

matrox[®]

Test & Measurement 2017



Multimeters, clamps, testers and laboratory instruments

For professionals like you: contractors, technicians and engineers in the electrical sector



Measuring instruments

- For electrical installation testing
- For maintenance of industrial electrical and electronic systems
- For metrology: precision measurements
- For design work: research and development

From design through to industrialization

- Measurement of electrical quantities in total safety



Rugged, reliable, portable instruments which are high-quality, safe and easy to use

- Sales agencies and staff at your service
- Technical centres: calibration and repairs
- A multi-product website and mini-sites dedicated to specific product ranges

Expertise

- Technical support, training, mock-ups, etc.

A response based on instruments designed, developed, manufactured and checked by professionals in the electrical sector

CONTENTS

The Group: History & Values...

Innovations, Ergonomics & Awards	2
Illustrated Table of Contents	4

Multimeters 6

Testers	
Selection guide	8
SMD Testers	9
LF electric field testers	10
Voltage tester	12

Multimeters	
MX1 & MX2B analogue on-site multimeters	13
On-site multimeter selection guide	14
Digital on-site multimeters	16
• MTX 202 & MTX 203 family	16
• MX Concept RMS family: MX 24 & MX 24B	18
• ATEX MX 57Ex for difficult environments	20
• ASYC IV family	22
• MTX 3290 & MTX 3291	24
• MTX 3292 & MTX 3293	26
• Clamps for multimeters	28
Laboratory multimeters	30
MX 5006 & MX 5060 laboratory multimeters	30

Software for multimeters	32
SX-DMM	32
SX-ASYC2C/B, MX 57EX-CAL & HX 0059	33
Communication accessories	34

Multimeter clamps	35
Selection guide	35
MX350 & MX 355 Series	36
MX 650 & MX 655 Series	37
MX 670 & MX 675 Series	38
PX 110 & PX 120 wattmeters	39
Analogue voltmeter MX 125	40
Analogue ammeter MX 135	40

Electrical safety testers	41
Insulation testers	41
MX 406B & MX 604	42
MX 407	43
MX 435D multi-function installation tester	44

NF C 15100 training	45
----------------------------	-----------

Oscilloscopes

Introduction to analogue oscilloscopes	46
Introduction to digital oscilloscopes	47
Selection guide for analogue and IN@BOX oscilloscopes	49
Scopein@box	50
MTX 162	52
MTX 112	53
MTX 1052 & MTX 1054	54
OX 530	56
OX 803B	56
OX 71	56
Selection guide for benchtop digital oscilloscopes	57
OX 6062B, OX 6202 & OXi 6204	58
DOX 2000	60
DOX 3000	62
Software for benchtop oscilloscopes	64

Selection guide for on-site oscilloscopes	65
OX 5022 & OX 5042 Handscope	66
SCOPIX family	68
SCOPIX for industrial maintenance: OX 7042 & OX 7104	70
SCOPIX for electronics: OX 7062, OX 7102, OX 7104, OX 7202 & OX 7204	71
Scopix Fieldbus: OX 7202BUS & OX 7204BUS	72
PROBIX accessories	73
OX software accessories: SX METRO & virtual printer	76
OX software accessories: SCO PE ADMIN & SCO PENET	77

Spectrum 78

Spectrum analyser connected to PC: MTX 1050	80
EMC prequalification: HX 0082 & HX 0083	82

Generators 83

Generator selection guide	85
LF generators: GX 305, GX 310 & GX 320	86
GX 1025 & GX 1050 generators	88
Laboratory power supplies	90
Selection guide	90
AX 501, AX 502 & AX 503	91
AX 1360-P	92
Training equipment (shunts, etc.)	93
CX 1651 multi-function laboratory calibrator	94
Accessories for multimeters	96
Accessories for oscilloscopes	97

Accessories

Accessories for multimeters	96
AC current clamps	98
Flexible AC current sensors	99
AC/DC current clamps	100
Current clamps for specific requirements	101
Generic cables and accessories	102
K-thermocouple and Pt100 probes and sensors	104
Transport and protection accessories	106
Accessories for oscilloscopes	107
Voltage probes	108
MX 9030, MTX 1032B & MTX 1032C differential voltage probes	110
Insulated current sensors	112
Flexible current sensors	113
Coaxial accessories	114
Transport and protection	115
Fuses	116

Index

By product	117
By function	119
By reference	121

USB	Power	Diode test	Frequency	Smart persistence oscilloscope	IEC 61010 electrical safety	Protection rating
Ethernet	Capacitance	Min, Max, Avg and PEAK	Resistance	Fourier transform	IEC 61010 electrical safety	
Android	Current	Measurement with current clamp	Reactive power	Multimeter	2.5 or 50-kpoint memory depth	
Recording	Continuity	3 sockets	Apparent power	MATH functions	50-kpoint memory depth	
Temperature	Voltage	Decibel	Harmonics	cos φ	2-Mpoint memory depth	



Technological Breakthroughs and Patented Discoveries

A French brand known nationwide by generations of electricians and electronic engineers, Metrix® is Chauvin Arnoux's flagship brand in electronics for multimeters, oscilloscopes, power supplies and generators.

The Engineering Department and R&D teams are still based on the site at Annecy-le-Vieux, but they can now take full advantage of the high-performance industrialization tools on the Group's production sites in Normandy.



1950: launch of the MX 460...



...and the MX 400 electro-clamp



ASYC IV 100-kcount colour graphical multimeter

Metrix: from the lampmeter, the electro-clamp and oscilloscopes to “the Metrix”

In 1936, Georges Friédrichs founded a small company named CARTEX. This company enjoyed considerable growth during the years of economic expansion following the Second World War.

Its main business was manufacturing **portable “lampmeters”** for checking the valves used in the radioelectricity sector, which was growing fast at the time. With the rising demand for electrical and electronic measurement equipment, CARTEX quickly became a major player in this sector, with products such as **the lampmeter, testers and frequency generators**. In 1946, it changed its name to “*Compagnie Générale de Métrologie*” (General Metrology Company) and began marketing its products under the Metrix brand.

The launch of the “**electro-clamp**”, allowing users to check voltages without disconnecting and measure high currents with one hand, and the production of oscilloscopes from 1948 onwards helped to quickly expand the company's offering. However, the products that really made the brand's reputation were the **MX 460**, launched in 1950, and more particularly, the **MX 462** multimeter, which was so successful that it helped the company to grow very quickly.



Healthy Rivalry

Based in Annecy, the company continued to expand, boosting the local economy, but Metrix's success and expertise in the measurement field quickly drew the attention of large industrial companies and, in 1964, ITT International (International Telegraph and Telephone) took over the company and incorporated it into its instrumentation division to develop analogue and digital multimeters.

With the development of the instrumentation market, the spread of information technology offering new possibilities, the increasingly international competition and the changes in the technological and standardization requirements, Metrix joined the Chauvin Arnoux Group in 1997.

This was followed by several years of good-natured competition between Chauvin Arnoux's teams and the Metrix R&D Department.

This gave rise to product ranges such as the MTX Concept multimeters, Scopix oscilloscopes and the MTX Mobile generation of products, as well as the ASYC IV Series more recently.

Today, Chauvin Arnoux and Metrix® have merged to offer a complete range of portable and laboratory instruments for electricians and electronic engineers, covering all our customers' needs.



MX 24B



OX 5042



Scopix OX 7104



The MX 135 analogue multimeter



ASYC IV MTX 3292 colour graphical 100-kcount multimeter

Digital multimeters, oscilloscopes and function generators are designed under the Metrix® brand renowned for its innovations in terms of design, ergonomics and technology. As the inventor of the key switch (MTX mobile®), the smallest oscilloscope with isolated channels on the market (Handscope®) "flip" multimeter (MTX mobile®), the brand's instruments regularly win awards for their innovative features.

Chauvin Arnoux is an industrial group with a comprehensive offering covering the whole measurement sector

Three French companies, **Chauvin Arnoux**, **Pyrocontrole** and **Enerdis**, offer expertise in portable instrumentation, thermal processes and electrical equipment, and energy efficiency solutions, respectively. **90 % of the products are designed and manufactured entirely in one of Group's six Research and Development centres.** Chauvin Arnoux benefits from production sites mainly based in Normandy, France. Every year, it proposes a palette of more than **5,000 product references** to meet the needs of contractors, government authorities and major customers in industry.

Integrated service!

Alongside this extensive, comprehensive offering, 12 agencies under the Manumasure brand provide high-quality, nationwide metrology and regulatory testing services (repairs, metrological verification, pollution measurement, etc.). This expertise is also provided internationally via the ten local subsidiaries.



Design and production in-house

Every year, the Group invests nearly 10 % of its sales revenues in Research and Development to maintain its technological leadership and its reputation for design and constant innovation. Designed in its R&D centres in France, Austria and the USA, the Group's measuring instruments are manufactured in Chauvin Arnoux's factories. The plastic and metal mechanical parts are made in Vire while the printed circuits are etched in Villedieu. Assembly, conditioning, storage and shipment worldwide are all handled on the Reux (Pont-l'Évêque) site in Normandy.

EcoDesign

For several years now, the Group has been implementing an ecologically-responsible approach intended to reconcile protection of the environment and the economic imperatives. The Chauvin Arnoux Group's EcoConception (ecodesign) label highlights the company's commitment to recycling and recovery of products from the design phase onwards.



International presence

10 subsidiaries in Europe, the USA, China and the Middle East, backed by export sales teams, support the Chauvin Arnoux Group's international development and promote its Chauvin Arnoux, Metrix, Multimetrix, Enerdis, Pyrocontrole, AEMC and AMRA brands on all five continents.



All the Chauvin Arnoux Group's sites are certified ISO 9001 and ISO 14001.



Education

Electricity, electronics, physics, industrial maintenance & the environment: disciplines which constantly involve measurement...

From middle schools... to higher education

When studying Science and Technology, measurement is essential for assessing and understanding the theoretical phenomena through practical experiments. In both initial and higher education, it is important to determine the characteristics of a component or system, its behaviour in its environment and its evolution over time, using our measuring instruments. Our offering covers everything from

easy-to-use instruments for initial training through to the more complex tools encountered by students when they start their working life.

➔ See examples in the magazine "Les Cahiers de l'Instrumentation" (in French) which deals with measurement in all its forms: news, practical exercises for high schools, reports, etc.



Initial training & Electronics

In middle schools, one of the first tasks for students involves measuring the electrical quantities and then viewing the waveform of a signal. Multimeters or oscilloscopes with a multimeter function are ideal for this initial familiarization and

identification of the fundamental characteristics: amplitude, frequency, etc.

➔ View the case studies available on our website: <http://www.chauvin-arnoux.com/en/notes-dapplication>



Electrical Engineering classes

In these classes, the subjects examined include converters, motors, generators and transformers. This training includes a large number of measurement operations characterized by the presence of significantly higher voltages and currents. Understanding and mastering electrical safety are crucial themes. From Voltage Absence testing with a voltage detector through to the multimeters and clamp multimeters used for TRMS measurements (AC/DC/ AC+DC), the measuring

instruments used for recurrent measurements are equipped with functions ranging from the simplest (resistance, continuity, capacitance, etc.) to the most complex (differential and relative measurements, etc.).

➔ Professional training
As a certified training organization since 1993, (certification no. 11.92.06217.92), CHAUVIN ARNOUX proposes specific training courses. <http://www.group.chauvin-arnoux.com/en/formations>



For further details...

Standards

EN 60529

The EN 60529 standard defines an instrument's level of tightness (leakproofing) to protect it from penetration by solids or water. The IP rating corresponds to the instrument's degree of protection against penetration by solids (1st digit) and against penetration by water (2nd digit). The higher the rating, the greater the protection. A product without protection has a rating of IP00 (minimum rating), while a product totally protected against penetration by solids and liquids is rated IP68 (maximum rating).

IEC 61010

This international standard defines the safety rules for electrical measuring, control and laboratory instruments. It helps to guarantee that the design and construction of the instruments ensure protection of users and their environment against: electric shocks, burns, mechanical hazards, fire propagation from these instruments, excessive temperatures, etc. For some types of instruments, this standard is completed with specific instructions.

The evolution of industrial and domestic equipment is increasing the hazards which may be encountered on electrical installations, with ever-higher overvoltages in particular. On LV installations, where the voltages are limited to 1,000 V_{AC} and 1,500 V_{DC}, the levels of risk are classified according to the type of installation and voltage level.

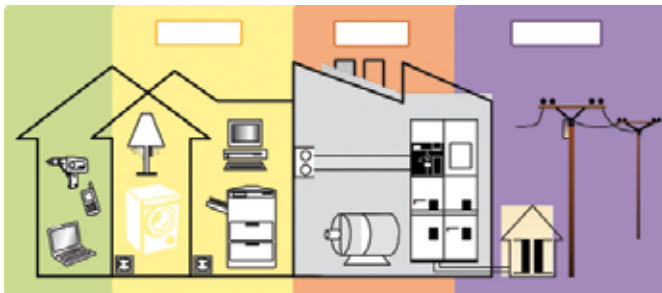

CAT II Measurements performed on circuits connected directly to the low-voltage installation.

Examples: domestic distribution systems, portable and domestic instruments and equipment, mains power sockets.

CAT III Measurements performed in the installation for a building.

Examples: fixed installations involved in industrial distribution and the entry circuits for electrical maintenance in buildings (lighting, lift/elevator, etc.).

CAT IV Measurements performed on the source of a low-voltage installation.

Examples: direct distribution, primary sources, overhead-line and cable systems, including distribution busbars and the related equipment for protection against voltage surges.

The IEC 61010 family of international standards indicates the safety rules for electrical measuring, control and laboratory instruments and their uses. More specifically, it is the IEC 61010-

031 standard and its amendment A1 which define the safety rules for measuring instruments and their accessories. In the new edition applicable from 1st March 2011, this standard was completed with the addition of Chapter 13 which deals with "prevention of hazards linked to short-circuits and electric arcs":

This modification imposes rules for work on CAT III and CAT IV installations:

- For the test probes, the conducting part of the accessory must not be longer than 4 mm
- For crocodile clips, the external surfaces of the jaws must be No-conducting and the conducting parts must not be accessible when the clip is closed.

The IEC 61010-2-033 standard, whose first edition was published on 9/02/2013, brought changes concerning multimeters, clamp multimeters, etc.

Since 9th March 2015, these instruments must ensure a level of safety corresponding at least to 300 V CAT III.

IEC 61557

This international standard specifies the electrical safety features in 1,000 V_{AC} and 1,500 V_{DC} low-voltage distribution networks. It defines all the requirements for the combined measurement and supervision systems which measure and monitor the electrical parameters on electrical distribution networks. These requirements also define the performance levels on single and three-phase AC or DC networks with rated voltages less than or equal to 1,500 V_{DC}.

The main parts of the IEC 61557 standard applicable to measurement and testing in our sector are:

- | | |
|----------------------|--|
| Part 1: IEC 61557-1: | General information |
| Part 2: IEC 61557-2: | Insulation resistance |
| Part 3: IEC 61557-3: | Loop impedance |
| Part 4: IEC 61557-4: | Resistance of earth and equipotential bonding |
| Part 5: IEC 61557-5: | Resistance to earth |
| Part 6: IEC 61557-6: | Effectiveness of the residual current devices (RCDs) in TT, TN and IT networks |
| Part 7: IEC 61557-7: | Phase sequence |

NF C 15-100

This is the official French safety standard governing the protection of low-voltage electrical installations and the people close to them, as well as easy management, use and upgradability of the installation. Residential installations (house or apartment) must comply with this standard.

In particular, NF C 15-100 defines the protective devices, RCDs, wiring, number and type of lighting point, as well as the number of power sockets according to the type of room (bathroom, kitchen, etc.).

New Products

All our products comply with the safety standards and new products were added to the Metrix® range in 2015:

The B ASYC multimeters to complement the ASYC IV models: a revitalized range for your basic measurement needs

Basic measurements...
B ASYC



Expertise required...
ASYC IV range



4-CHANNEL benchtop oscilloscopes
For the electronics sector...



DOX range

For electrical engineering and power electronics...



OXi6204



And more are on the way...

Technical reminders

Number of measurement counts

This is one of the fundamental specifications of instruments using analogue-digital conversion. In general, it can be used to define the measurement range and the resolution, on the basis of the value chosen for the rated calibre.

Measurement range

This indicates the limits within which the digital instrument maintains all its specifications, so the indications obtained are not subject to an error greater than the maximum tolerated error. It is defined by a minimum value and a maximum value.

Rated calibre

The calibre of an instrument is the value of the quantity to be measured which corresponds to the upper limit of the measurement range. For example, for an ammeter, if this upper limit is 5 A, its calibre is said to be 5 A.

Resolution

This is the smallest measurable value. It is also the value of a measurement count or quantification unit, usually termed "the unit".

Minimum measurable value (or threshold)

This is the smallest measurable value. For an instrument with good linear conversion, it may be equal to the resolution. This is not always the case and the manufacturer should clearly indicate it, as this minimum value also depends on the accuracy and, more particularly, the standard error.

When the standard error is too high, it becomes impossible to measure very low values reliably.

RMS: Root Mean Square

By definition, the RMS value of any current is the DC current value which would cause the same heating when flowing through a resistor.

$$V_{rms} = \sqrt{\frac{1}{T} \int_0^T v(t)^2 dt}$$

In the specific case of a sinusoidal quantity, application of the above equation yields:

$$v = V_{peak} \cos \omega t$$

$$V_{rms} = \sqrt{\frac{1}{T} \int_0^T v_{peak}^2 \cos^2(\omega t)^2 dt} = \frac{V_{peak}}{\sqrt{2}}$$

The amplitude (Vpeak) of a voltage or sinusoidal current is equal to $\sqrt{2}$ times its RMS value (Vpeak = $\sqrt{2}$ Vrms).

Knowledge of this RMS value is essential in the industrial sector as it is this value which is used to define a current.

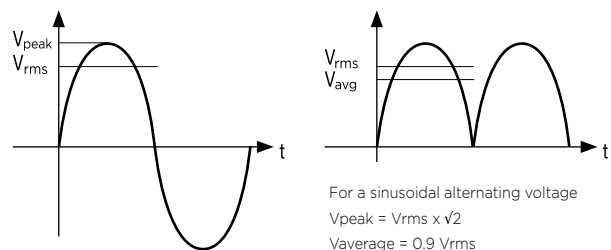

So, for the 230 V/50 Hz network:

$$V_{RMS} = 230 \text{ V} ; V_{peak} = 325 \text{ V} ; V_{avg} = 207 \text{ V}$$

An "average value" measuring instrument measures the average value of a sinusoidal current, after rectification and filtering and displays the RMS value after application of a coefficient equal to $1/0.9 = 1.111$.

This indirect measurement method is simple and accurate, but it is only valid for sinusoidal currents without distortion. It only tolerates distortion amounting to a few per cent.

This is why "RMS" measuring instruments are seeing increasing use. They are based on direct measurement principles: thermal measurement (used mainly in metrology) and analogue or digital calculation methods requiring sophisticated electronic components.

Peak value – Crest Factor

The crest factor is defined as follows:

$$CF = V_{\text{peak}} / V_{\text{rms}}$$

This additional information complementing the RMS value can be used to assess the distortion of a signal in qualitative terms. For a sinusoidal signal, $CF = \sqrt{2} = 1.414$.

Advice: When we speak of a 230 V network voltage, it is an RMS value. For many years, the linear loads (incandescent lamps, heating) connected to the network caused very little distortion. The spread of No-linear loads (switching power supplies, light dimmers, variable speed drives and compact fluorescent lamps) is calling this approach into question because the network's "pure" sinusoid is becoming increasingly rare.

Conventional measuring instruments (which give the "effective" value on the basis of the average value) are only accurate, by definition, with sinusoidal currents. Otherwise the measurement error may be as high as 50 %!

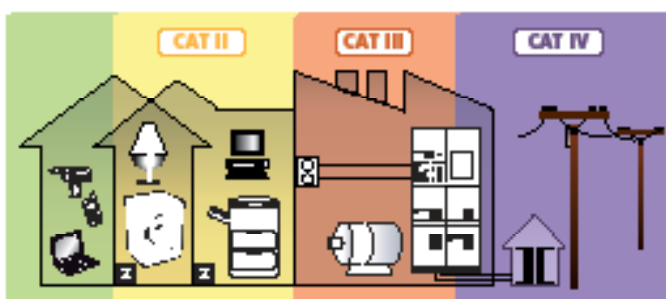

You are advised to choose RMS measuring instruments capable of providing correct measurements whatever the waveform of the current or voltage.

Safety rules and good practice:

- Use measuring instruments and accessories suitable for the application and measuring conditions.

Prefer CAT IV instruments:

- It ensures a voltage withstand up to 50% higher than a CAT III product
- 1,000 V CAT IV means protection against electric shocks up to 12,000 V, while 600 V CAT IV instruments protect up to 8,000 V.
- If you use a lower-category instrument, you must ensure that the installation is equipped with protective systems (disconnecting switch, circuit breaker, etc.) which are functional and in good condition. This is often the case... but not always!
- For outdoor or temporary installations, or for installations upstream of the protective systems, CAT IV instruments are mandatory.

- It is the weakest element which defines your level of protection. If you use accessories with a lower category or voltage rating than your measuring instrument, the overall safety level offered by your measurement system is also reduced.

- Use accessories in perfect condition. Any accessories presenting even the slightest defect must be replaced immediately because they no longer guarantee your safety.

- Fuses are protective devices. If you replace them with cheaper models or, even worse, with a metal element (copper wire, aluminium foil, etc.), they will not protect you from possible voltage surges on the installation.

Selection guide

Choose your tester or analogue multimeter



Types	SMD tester	Voltage tester	Analogue multimeters		Field testers	
	TCX 01	TX 01	MX 1	MX 2B	VX 0003	VX 0100
Specifications						
Voltage measurement		AC	AC and DC	AC and DC		
Resistance measurement	X	X	X	X		
Capacitance measurement	X					
Diode test	X		X	X		
Continuity test	X	X	X	X		
Phase identification		X				
Current measurement			AC and DC	AC and DC		
Current measurement with clamp				MN09 200A	X	X
LF electric field measurement (V/m)					10Hz-3 KHz	10Hz -100KHz
LED - analogue display		X	X	X	X	
Digital display	X					X
Power supply: battery / type	2x1.5v /LR44	1x9V/6F22	1x 1.5V/LR6		1x9V/6F22	
Pages	9	12	13	13	10-11	

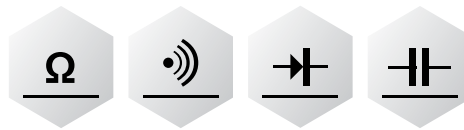

Surface Mount Device (SMD) tester

TCX 01

Ergonomic, simple and quick for instant SMD identification.

- Automatic recognition of the SMD
- Wide dynamic range for measurement (6,000 counts for accurate testing of the highest and lowest values)
- Immediate implementation
- Test probes protected by a rigid cap



Specifications		TCX 01	
Display	6,000 counts		
Selection of ranges	Automatic or Manual		
	Range	Resolution	Accuracy
Resistance	600 Ω	0.1 Ω	±(1.2 % of reading + 2 digits)
	6 kΩ	1 Ω	
	60 kΩ	10 Ω	
	600 kΩ	100 Ω	
	6 MΩ	1 kΩ	
Capacitance	60 MΩ	10 kΩ	±(2 % of reading + 2 digits)
	6 nF	1 pF	±(5.0 % of reading + 5 digits)
	60 nF	10 pF	±(3.0 % of reading + 3 digits)
	600 nF	100 pF	
	6 μF	1 nF	
	60 μF	10 nF	±(5.0 % of reading + 5 digits)
	600 μF	100 nF	
	6 mF	1 μF	
60 mF	10 μF	-	
Diode and semiconductor junction test	2 V	$I_{\text{test}}: \sim 1 \text{ mA} / V_{\text{test}}: \sim 2.8 \text{ V}$	
Continuity test	R < 30 Ω		
Automatic shutdown	10 min		
Power supply	2 x 1.5 V AG13 / LR44 / 357A		
Dimensions / weight	181 x 35 x 20 mm / 65 g		



Standard state at delivery:

TCX001-Z: 1 TCX delivered with soft case for storage, 2 x 1.5 V button cells and operating manual

Accessories: Set of 2 x 1.5 V LR44 batteries..... P01296036



VX 0003 & VX 0100

Measure your exposure to electromagnetic pollution in your home or office. The **VX 0003** and **VX 0100** testers are easy-to-use, economical and trustworthy! They are used mainly when testing new or renovated electrical installations and in technical and vocational training.

The VX 0003 and VX 0100 BioTest field testers/meters instantaneously indicate the level of the low-frequency electric field. Ideal for the residential and tertiary sectors, they can be used by both professionals and DIY enthusiasts.



- Test of the pollution generated by electrical power distribution (0-3 kHz) (VX 0003/VX 0100)
- Test of the pollution generated by the equipment connected (3-100 kHz) (VX 0100)
- 2 complementary methods for more effective measurements
 - Representative method: field measurement while taking the individual's presence into account
 - Traditional method: fields referenced to earth
- External antenna for field measurement and cable detection (VX 0100)
- Audible alarm for immediate identification of the field levels
- Testing in accordance with the current and future standards and directives



Example of application

Low-frequency fields between 10 Hz and 100 kHz are harmful.

Standards

- WHO / ICNIRP recommendations (World Health Organization / International Commission on No-Ionizing Radiation Protection)
- IEEE C95.6-2002 (international standard - Public, 0-3 kHz range)
- European Directive 1999/519/CE (Public, 0-100 kHz range and beyond)
- European Directive 2004/40/CE (Workers, 0-100 kHz range and beyond)
- 2010 draft standard, EN IEC 62493 (lighting systems)
- EN50366 standard and IEC 62233 in 2012 (domestic electrical equipment)

Technical specifications	VX 0003	VX 0100
Display & Buzzer		
Display on 2 scales of 7 LEDs each	•	
2,000-count backlit LCD display		•
Direct display in Volt/m (compatible with standards)	•	•
Buzzer proportional to the field level	•	•
Indication of the measurement frequency range		•
"Low battery" & "Hold" indicators	•	•
Commands		
On / Off (with automatic shutdown after 30 min)	•	•
Measurement Hold	•	•
Buzzer On/Off	•	•
Selection of measurement range	Manual	Automatic
Selection of 3 kHz filter (<, >, full band)		•
Antenna & Reference		
Built-in "field" antenna	•	
Removable "field" antenna, diameter 62 mm + Cable detection function		•
"Individual" field measurement reference + continuity rod	•	•
"Earth" field measurement reference	•	Optional accessory
Measurements		
RMS electric field intensity in V/m	•	•
Sensitivity & Accuracy		
2 sensitivity ranges (compatible with standards)	5 to 100 V/m - 100 to 2,000 V/m	1.0 to 200.0 V/m - 200 to 2,000 V/m
Measurement accuracy (in laboratory conditions)	± 10% on LED thresholds	± 3% ± 20 D @ 50/60 Hz
Frequency range		
Analysis of electrical distribution, 10 Hz to 3 KHz	•	•
Analysis of equipment connected to the mains	10 Hz to 3 kHz	10 Hz to 3 kHz (3 kHz low-pass filter) 3 kHz to 100 kHz (3 kHz high-pass filter) 10 Hz to 100 kHz (no 3 kHz filter)
General specifications		
Power supply	9 V battery (supplied) - Battery life 60 to 80 hours Automatic shutdown function (30 min)	
Mechanical specifications	IP65 leakproof casing- Dimensions 63.6 x 163 x 40 mm - Weight approx. 200 g with battery	
Warranty	2 years	

Standard state at delivery

1 VX delivered with earth cable, socket tester and 9 V battery



Specific optional accessories

1 VX delivered with earth cable, socket tester and 9 V battery

Bag for VX testers



Continuity rod

References to order

VX0003: VX0003 field tester delivered with a bag
 VX0100: VX0100 field tester delivered in a case

For the VX 0100:

- Continuity rod.....P01102084
- Continuity rod adapter.....P01102034
- HX0104 bag

For the VX 0003:

- HX0009 case



For further details...



LED voltage tester TX 01

An essential tool for electrical testing and diagnostics.

- AC and DC voltage testing
- Electrical continuity testing with audible and visual indication
- Phase identification
- Autotest function to check the status of the instrument and the battery
- Extra-bright LEDs
- Removable test probe with standard $\varnothing 4$ mm banana connection
- Built-in system for stowing the lead



Specifications	TX 01
Voltage test	12 V to 690 V (7 diodes)
Audible alarm	U > 50 V
Phase identification	Flashing "Ph" diode for U > 100 V-
Operating frequency	DC ... 400 Hz
Audible continuity	Yes
Resistance	2 k Ω to 300 k Ω (3 diodes)
Power supply	1 x 9 V 6F22
Electrical safety	600 V CAT III
Dimensions / Weight	193 x 47 x 36 mm / 170 g
Other features	Built-in 1.2 m lead with $\varnothing 2$ mm test probe + $\varnothing 2$ mm removable test probe

Standard state at delivery

TX0001-Z: delivered with a removable test probe, a 9 V battery and an operating manual



MX1 & MX2B

With their needle and dial, the MX 1 and MX 2B multimeters are easy to read and quickly display the measurement results.



- IP65 shockproof and leakproof casing
- Audible continuity
- Protection of the ohmmeter function by an audible alarm
- Parallax mirror for precise measurements
- Faulty fuse indicator
- Measurement up to 200 A with clamp (MX 2B)

Specifications	MX1	MX2B
Display	Analogue with parallax mirror / Scale length 80 mm	
DC voltage	10 mV to 600 V	
Calibres	150 mV / 0.5 V / 1.5 V / 5 V / 15 V / 50 V 150 V / 500 V / 1.5 kV ⁽¹⁾	0.01 V / 1.5 V / 5 V / 15 V / 50 V 150 V / 500 V / 1.5 kV ⁽¹⁾
Accuracy class	2	
AC voltage	10 mV to 600 V	
Calibres	5 V / 15 V / 50 V / 150 V / 500 V / 1.5 kV ⁽¹⁾	0.01 V to 600 V 5 V / 15 V / 50 V / 150 V / 500 V / 1.5 kV ⁽¹⁾
Accuracy class	2.5	
DC current	2 µA to 10 A	
Calibres	50 µA / 500 µA / 5 mA / 150 mA / 500 mA / 1.5 A / 10 A	1 µA to 50 µA / 10 A 50 µA / 10 A
Accuracy class	2	
AC current	20 µA to 10 A	
Calibres	50 µA / 500 µA / 5 mA / 150 mA / 500 mA / 1.5 A / 10 A	With a 1,000/1 clamp 10 A / 20 A / 100 A / 200 A
Accuracy class	2.5	
Resistance	Audible alarm for voltage presence	
Calibres	x 1 / x 10 / x 100	
Middle point	200 Ω / 2 kΩ / 20 kΩ	
Accuracy class	2.5	
Audible continuity	< 150 Ω	
Other measurements		
Diode test	Yes	
dB	Yes	
Protection rating	IP 65	
Power supply	1 x 1.5 V AA or LR6	
Electrical safety	600 V CAT III as per IEC / EN 61010-1 Edition 2	
Dimensions / Weight	40 x 98 x 150 mm / 420 g	

(1) Use limited to 600 Vmax

Specifications	MINI 01	MN 09
Clamping diameter	10 mm	20 mm
Measurement range	2 A to 150 AAC	0.5 A to 200 AAC
Transformation ratio	1,000/1	1,000/1

Standard state at delivery

MX 1 with 1 set of measurement leads with test probes, 1 x 1.5 V battery and user manual in 5 languages
 MX 2 with 1 set of measurement leads with test probes, 1 x 1.5 V battery, 1 current clamp and user manual in 5 languages

Available accessories

See pages 97 to 106

References to order

MX1: 1 MX 1
 MX0001-T: 1 MX 1 delivered with 1 TX1 voltage tester and a hard case.
 MX0002B: 1 MX 2B delivered with an MN09 current clamp
 MX0002BT: 1 MX 2B delivered with an MN01 current clamp, 1 TX1 tester and a hard case
 P01105101Z: 1 MINI01 current clamp
 P01120402: 1 MN09 current clamp
 TX0001-Z: 1 TX01 LED tester



MX 2B with MN 09



For further details...

Selection guide

Multimeter families to meet all your needs:



Quick selection	High-End Graphical Multimeter/Recorder
	Industry, Electrical Engineering, Electronics
	MTX 3292 MTX 3293

Technology	Graphical colour
Display resolution (counts)	100,000
TRMS / AVG measurement	TRMS AC & AC+DC
Simultaneous display(s)	4
Fast bargraph	•
Graph of measurements over time	•
Backlighting / Automatic power-off	•/•
DC basic accuracy	0.02 % to 0.1 %
Bandwidth	100 kHz or 200 kHz
Auto / Manual ranges	•/•
AutoPeak for Crest Factor	•
Ingress protection	IP67
Explosive atmospheres (ATEX)	
Available measurements	
AC/ DC voltage	1,000 V
AC/ DC current	20 A (30 s)
Single A terminal / Simultaneous U & I	•/•
Resistance / audible continuity / diode test	10 MΩ / •/•
Frequency / period / duty cycle	5 MHz / •/•
Pulse width / pulse count	•/•
Capacitance	10 mF
Temperature Pt100-Pt1,000 / TC J-K	•/•
dBm / resistive power	•/•
U & I peak / crest factor	250 μs / •
Filter for digital variable speed drives	300 Hz
Direct measurement with clamp	All, ratio integrated
Low impedance AC voltage measurement	500 kΩ
Measurement processing	
Display Hold / Auto-Hold functions	•/•
Min / Max / Avg monitoring	•/•/•
Relative measurements / dB ratio / %	•/•/•
Memory capacity + measurement graphs	6,500
Time/date-stamping (SURV & MEM)	•
RS232 / USB / Bluetooth interface	•/•/•
Safety & reliability	
EN61010 CAT IV / III	600 / 1,000
Electronic switch	•
Protected access to batteries / Fuses	•/•
"Closed casing" software calibration	•
Catalogue page	26-27

(1) Depending on models. (2) MTX 3291 model only

an authentic **metrix**® for everyone



Digital for Difficult Environments		General-purpose Digital		Benchtop Digital
Industry	Atex / IECEx	Electrical		Laboratory
MTX 3290 MTX 3291	MTX 57EX	MX 24 MX 24B	MTX 202 MTX 203	MX 5006 MX 5060
Digital	Digital	Digital	Digital	Digital
6,000 or 60,000	50,000	5,000 / 50,000 ⁽¹⁾	2,000 or 4,000	6,000 or 60,000
TRMS AC & AC+DC	TRMS AC & AC+DC	TRMS AC & AC+DC	TRMS AC	TRMS AC & AC+DC
2	1	1	1	2
•	•	•		•
•/•	-/•	•/•	-/•	•/•
0.08%	0.03%	0.30%	0.5% or 0.2%	0.80%
20 kHz or 100 kHz	50 kHz	1 kHz	1 kHz	20 kHz or 100 kHz
•/•	•/•	•/•	•/•	•/•
•				•
IP67	IP67		IP54	
	•			
1,000 V or 600 V	600 V	750 V / 1,000 V	750 V / 1,000 V	1,000 V or 600 V
20 A (30 s) ⁽¹⁾	500 mA	20 A (30 s) ⁽¹⁾	10 A ⁽¹⁾	20 A (30s)
•/•	•/-			•/•
60 MΩ /•/•	50 MΩ /•/•	50 MΩ /•/•	40 MΩ or 60 MΩ /•/•	60 MΩ /•/•
600 kHz /•/•	500 kHz /- /•	500 kHz /- /-		600 kHz /•/•
•/• ⁽¹⁾	•/•			•/• ⁽¹⁾
60 mF	50 mF	50 mF	100 mF	60 mF
•/-	•/-		-/•	•/-
•/• ⁽¹⁾	•/•			•/• ⁽¹⁾
250 μs /•	1 ms /-			250 μs /•
300 Hz		1 kHz BW		300 Hz
V/A ratio		•		
300 kΩ		•	500 kΩ	300 kΩ
•/•	•/•	•/•	•/-	•/•
•/•/•	•/•/•	•/•/• ⁽¹⁾		•/•/•
•/•/• ⁽¹⁾	•/- /-			•/•/• ⁽¹⁾
-				-
Relative Surv /•/- ⁽¹⁾	•/- /-			Relative Surv /•/- ⁽¹⁾
600 / 1,000 ⁽²⁾	- / 600	- / 600	- / 600	600 / 1,000
•				•
•/•	•/•	•/•	•/•	•
	•	•		•/•
24-25	21	18-19	16-17	30-31



Concept TRMS AC

The Metrix® tools of reference for applications in the electrical sector

MTX 202 & MTX 203

A range of 2 simple, basic TRMS AC multimeters with digital display for measuring on electrical networks and installations up to 600 V CAT III. These multimeters are general-purpose professional measuring instruments. They are the best tools for day-to-day use requiring the TRMS measurements, accuracy, rugged design and reliability of an on-site instrument.



- **Automatic TRMS AC** measurements on all the calibres for most of the customary electrical signals:
 - AC/DC voltage;
 - VLowZ low-impedance voltage;
 - temperature in °C and °F via K thermocouple;
 - resistance and audible continuity, diode threshold voltage test;
 - capacitance measurement and AC/DC current measurement from 1 µA to 10 A (depending on model) plus manual RANGE
- **No-contact voltage (NCV)** indication useful for detecting live cables at 230 V
- A **compact casing** with a multi-purpose sheath which fits in one hand: stowing of the leads, magnetized for mounting on metal cabinets and shockproof protection with the MULTIFIX system
- **Blue backlighting** with torch for optimized display in dark environments
- **Automatic power-off** after 30 minutes without activity which can be inhibited (permanent mode) to optimize the 500-hour battery life and the lifespan of the batteries
- Easy access to the 2 x 1.5 V batteries and fuse(s) by loosening 2 screws on the rear
- Compliant with the latest **IEC61010-2-033 - 600 V CAT III** safety standards



Specifications	MTX202	MTX203
Quick selection		
Display resolution	4,000 counts	6,000 counts
Automatic power-off	30 min / Permanent mode	
Basic accuracy (Vdc)	0.2 %	
Bandwidth	1 KHz	
Available measurements		
AC/DC voltage (ranges)	400 mV to 600 V / 600 V	600 mV to 750 V / 1,000 V
AC/DC current (ranges)	20 mA to 10 A	10 µA to 10 A
Resistance (ranges)	1 Ω to 40 MΩ	1 Ω to 60 MΩ
Audible continuity	Yes	
Diode test	Yes	
Capacitance (ranges)	1 nF to 100 mF	
NCV	230 V / 50 Hz	
Temperature	-55 °C to 1,200 °C	
Measurement processing		
Other measurements	HOLD mode	
General specifications		
Power supply / Battery life	2 x 1.5 V batteries / 500 h	
Dimensions / Weight	170 x 80 x 50 mm / 320 g	
Safety and reliability		
Electrical safety	EN61010-02-33 - 600 V CAT III	
High-resistance casing	IP 54	
Warranty	2 years	

Standard state at delivery

1 multimeter with batteries and fuses installed, 1 elastomer sheath with stand, 1 set of 2 safety leads, 1 wire K thermocouple, user manual

Specific or adapted accessories



Bag: HX0052B



SHT 40kV probe: P01102097



K Thermocouple: P01102107Z

References to order

MTX202-Z: MTX202 delivered in blister pack
 MTX203-Z: MTX203 delivered in blister pack

Available accessories

See pages 97 to 106



For further details...



TRMS AC & TRMS AC+DC Concept

MX 24 & MX 24B

TRMS measurements for accurate results whatever the waveform.



- Bandwidth up to 100 kHz
- A V_{LowZ} low-impedance function to avoid stray voltages
- Innovative design with a compact, rugged casing
- Large display with bargraph and backlighting for easy reading
- Elastomer protective sheath
- Unique system for easy access to the batteries and fuses with extra safety
- MIN/MAX/AVG function to monitor the changes in the signal
- MEM/Auto mem function to allow you to freeze the display



Recyclable and recoverable, in compliance with the DEEE-2002/96/CE directive



Specifications	MX 24	MX 24B
Quick selection		
Display	5,000/50,000 counts + bargraph	
Backlighting/auto-shutdown	Yes / Yes	
TRMS measurements	TRMS AC+DC	
Basic accuracy for DC voltage	0.3 %	
Bandwidth	1 kHz	
Available measurements		
AC/DC voltage (ranges)	500 mV to 750 V _{AC} / 1,000 V _{DC}	
AC/DC current (ranges)	50 mA - 20 A	500 mA - 20 A
Resistance/audible continuity	500 Ω to 50 MΩ / Yes	
Frequency	5 Hz to 500kHz	
Capacitance / diode test	50 nF to 50mF / Yes	
Measurement processing		
Min/Max/Avg monitoring	Yes / Yes / No	
PC communication / backup	No	
Safety and reliability		
Electrical safety	EN61010-1, 2001 - 600 V CAT III	
Warranty	3 years	

Standard state at delivery

1 MX: 1 elastomer sheath, 1 set of 2 safety leads,
1 x 9 V battery installed

References to order

MX0024-CG: MX 24
MX0024-CL: MX 24 delivered in hard case
MX0024B-CZ: MX 24B in blister pack
MX0024B-CL: MX 24B delivered in hard case



Available accessories

See pages 97 to 106



For further details...

MULTIMETERS FOR DIFFICULT ENVIRONMENTS

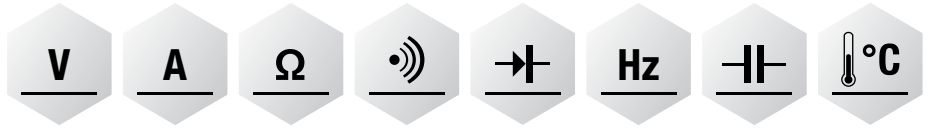

ASYC II multimeter
A unique tool for all your measurements usable in explosive and non-explosive environments

MX 57EX

This ATEX-certified 50,000-count TRMS digital multimeter is designed for use in hazardous environments.



Use in explosive gas and dust atmospheres in the following conditions:

- Mines: category I M2
- Surface industries: category 2 (gas and dust) I I 2GD
 - Zones 1 & 2 (gas) Ex ib I and Ex ib IIC T5 or T4 or T3
 - and zones 21 & 22 (dust) Ex ibD21 IP6X T°... °C

The MX 57Ex is a comprehensive instrument which complies with the applicable standards and regulations.

It also complies with the stipulations of the European directives:

- Low Voltage 2006/95/CE
 - Electromagnetic Compatibility EMC 89/336/CE and 93/68/CE
- ATEX 2014/34/UE directive
EN/IEC 60079-0 - EN/IEC 60079-11
EN/IEC 61241-11 - EN/IEC 61241-0
EN/IEC 61010-1 - 600 V CAT III

It is certified LCIE O2 ATEX 6005 X and, according to the "old regulations", EEx ib IIC T5 / EEx ib I according to:

- CE inspection certificate of type number LCIE O2 ATEX 6005 X and amendments LCIE O2 ATEX 6005X / 01, 02, 03, 04

It is equipped with a 500 mA fuse. It is supplied in a bag with some of its accessories.



The temperature class depends on the battery used :

Certified battery	Gaseous explosive atmosphere	Combustible dust atmosphere
DURACELL PROCELL	T5	T91 (°C)
POWER LINE	T4	T103 (°C)
ANSMANN	T4	T112 (°C)
SANYO	T4	T123 (°C)
ENERGIZER	T4	T124 (°C)
POWER ONE	T3	T133 (°C)

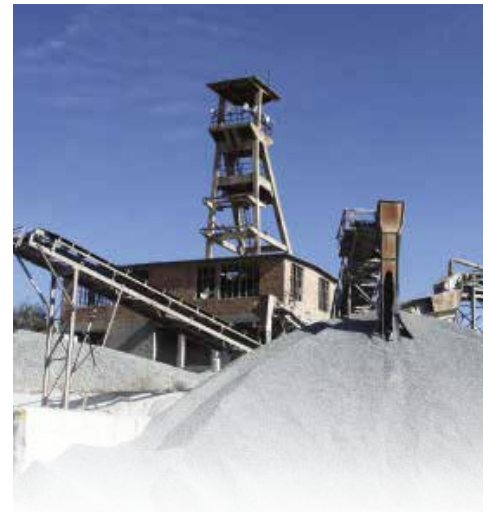

Specifications	MX 57EX
Display	50,000 counts
Bargraph	Analogue, 34 segments, 20 meas./s
DC, AC & AC+DC voltage	
Ranges	5 calibres from 500 mV to 600 V
V _{DC} accuracy	0.025 %
V _{AC} accuracy	0.3 %
Bandwidth	50 kHz
DC, AC & AC+DC current	
Ranges	500 µA, 5 mA, 50 mA & 500 mA
A _{DC} accuracy	0.2 %
A _{AC} accuracy	0.6 %
Bandwidth	5 kHz
Frequency	
Ranges	0.62 Hz to 500 kHz - Accuracy 0.03%
Other measurements	
Resistance	6 ranges from 500 Ω to 50 MΩ
Audible continuity	Detection threshold from 10 Ω to 20 Ω - response time 1 ms
Diode test	0 to 2 V
Capacitance	7 ranges from 50 nF to 50 mF
Temperature	-200 °C to +800 °C
	Pt100 or Pt1,000 platinum probes
Other features	Duty cycle - dB function and U ₂ /R resistive power Pulse width - timer - event counting
General specifications	
Battery life	1 certified 9 V battery / 300 hrs
Dimensions / Weight	189 x 82 x 40 mm / 400 g (without sheath/stand)
Safety and reliability	
Safety	ATEX 94/9/CE directive EN/IEC 60079-0 - EN/IEC 60079-11 EN/IEC 61241-11 - EN/IEC 61241-0 EN/IEC 61010-1 - 600 V CAT III + EN 61010-2-030 2010 CE inspection certificate type number LCIE 02 ATEX 6005 X and amendments LCIE 02 ATEX 6005X / 01, 02, 03, 04
High-resistance casing	IP 67
Warranty	3 years

Standard state at delivery

1 multimeter with battery and fuse(s) installed, 1 elastomer sheath with stand, 1 set of 2 PVC safety leads and 1 user manual

Reference to order

MX0057CX: MX 57 delivered in a specific soft case

Available accessories

See pages 97 to 106



For further details...

ASYC IV FAMILY OF DIGITAL MULTIMETERS

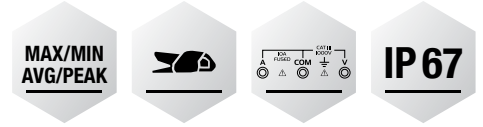

metrix® is revolutionizing multimeters with the ASYC IV

Multimeters with colour graphical screens for the lab or the field: the reference for multimeters.

- IP67 leakproof multimeters
- Graphical display of the trends and multiple parameters
- Bandwidth: 200 kHz
- Basic accuracy: 0.02 %
- Multiple analytical tools:
 - Time/date-stamped monitoring of MIN/MAX/AVG and PEAK
 - Direct current measurement with integration of the report



... Plus unrivalled simplicity of use, as always!

- Directly accessible, the various measurements are represented explicitly by pictograms on the electronic switch
- The display allows users either to view the measurement results as numerical values, on 2 display levels, or as graphs showing the trend over time



Digital keypad which lights up the active function, storage of configurations



metrix® is revolutionizing multimeters with the colour graphical ASYC IV models

The ASYC IV multimeters are ideal for many applications in industry, telecommunications and Defence.

Their multiple functions make them easy to use for electrical, electronic or machine maintenance.

In electronics, the ASYC IV models can be used to test cabling, computing or medical equipment or SMDs.

In industry, they are suitable for the applications encountered in departments dealing with the automated systems and processes in highly varied sectors: food, plastics, concrete, metal, paper, wood, oil and nuclear.

The ASYC IV models can be used for maintenance of many industrial machines: numerical control, motors, generators, etc.

These versatile instruments are ideal for the needs of expert electrical installers and professionals in the transport and energy sectors.

High-performance, accessible and ergonomic, the ASYC IV models can also be used in training and research.

This recorder-multimeter offers:



Colour 320 x 240-pixel liquid-crystal matrix screen with black background for easier reading

- Graphical display of the trends on an overview screen
- Trace, cursors and zoom on recordings
- Recording of 10 sequences



Dynamic recorders...

- Up to 6,500 measurements stored in memory
- Simplified definition of the number of measurements, the interval, the duration and the memory capacity
- Internal storage of the 10 measurement sequences
- Interactive zoom function on the recordings
- A simple monitoring mode displaying the time/date-stamped MIN/MAX and AVG values

■ The four ASYC IV models

Models	LCD MTXs		GRAPHICAL MTXs	
	MTX 3290	MTX 3291	MTX 3292	MTX 3293
Type of display	Digital monochrome 70 x 52 mm	Digital monochrome backlit 70 x 52 mm	Colour graphical 70 x 52 mm	
Type of display	7 function keys + setup			
Counts	6,000	60,000		
Data storage			1,000 meas.	6,500 meas.
Power supply	4 x R6 batteries or 4 rechargeable batteries			
Communication		IR / USB	IR / USB (Bluetooth option)	

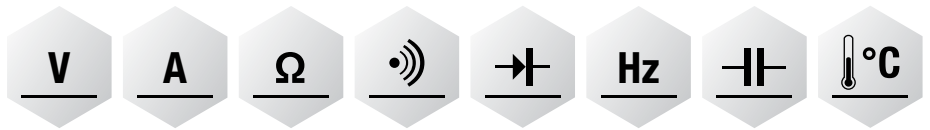

MTX 3290 & MTX 3291

The METRIX® designed for the field: a single, comprehensive, high-performance diagnostic instrument which nevertheless remains particularly easy to use!

- An innovative design with ergonomics suited to work in the field: fingertip function selection on the numeric keypad and comfortable grip, a large backlit LCD screen (3 positions) for viewing 2 simultaneous measurements (segments 14 mm high)
- Unrivalled user-friendliness:
 - "Virtual" one key / one function
 - Automatic V/A selection by cable positions and 8 backlit function keys
- Up to 2 x 60,000-count digital displays + bargraph: central zero, V_{dc} and I_{dc}
- 3 connection terminals, so a single fuse from 1 μA to 10 A
- Reminder of the measurement connections for each function
- Extra-versatile: V, A, Ohms, Hz, diode, capacitance, dB, °C, etc. Low-impedance measurement, time/date-stamped MIN, MAX and AVG monitoring, etc.
- CLAMP function for direct measurement of the current by integrating the transformation ratio: 1/1, 1/10, 1/100 and 1/1,000 mV/A
- Secondary measurements for electronics: DBm, resistive power, counting, pulse width, gain measurement, resistive power
- Communication for MTX 3291: isolated USB; "real-time" data transfer onto PC, drivers and SCPI commands



Multimeters with fingertip control

Unique on the market, the electronic switch replaces the traditional mechanical switch, which is the major source of faults on handheld multimeters, while also improving performance and safety. At the same time, the possibility of direct access using the keypad avoids the intermediate positions typical of mechanical switches.

Each main measurement is instantaneously accessible with one of the 6 dedicated keys, without having to choose between the 4 or 5 positions of a mechanical switch for a simple voltage or current measurement.

Technical specifications	MTX 3291*				MTX 3290			
Length of scale								
Range	60 mV	600 mV	6 V	60 V	600 V	1,000 V		
Resolution*	0.001 mV	0.01 mV	0.0001 V	0.001 V	0.01 V	0.1 V		
DC accuracy	0.05 %			0.3 %				
AC and AC+DC bandwidth	100 kHz			20 kHz				
AC and AC+DC basic accuracy	0.5 %			0.8 %				
VLowZ AC	300 k Ω							
DC, AC and AC+DC current								
Range	600 μ A	6 mA	60 mA	600 mA	6 A	10 A / 20 A (30 s max)		
Resolution*	0.01 μ A	0.1 μ A	0.001 mA	0.01 mA	0.1 A	0.1 A		
DC accuracy	0.08 %							
AC and AC+DC bandwidth	20 kHz			20 kHz				
AC and AC+DC basic accuracy	1 %			1.5 %				
Frequency								
Frequency range	60 Hz	600 Hz	6 kHz	60 kHz	600 kHz			
Resolution*	0.01 Hz	0.1 Hz	1 Hz	10 Hz	100 Hz			
Resistance and continuity								
Ranges	600 Ω	6 k Ω	60 k Ω	600 k Ω	6 M Ω	60 M Ω		
Resolution*	0.1 Ω	1 Ω	10 Ω	100 Ω	1 k Ω	10 k Ω		
Basic accuracy	0.2 %			0.5 %				
Protection	Electronic protection							
Audible continuity detection	600 Ω SIGNAL < 30 Ω +/- 5 Ω < 5 V							
Diode test								
Voltage measurement	3 V - resolution 1 mV							
Capacitance								
Ranges	6 nF	60 nF	600 nF	6 μ F	60 μ F	600 μ F	6 mF	60 mF
Resolution*	0.001 nF	0.01 nF	0.1 nF	0.001 μ F	0.01 μ F	0.1 μ F	1 μ F	10 μ F
Temperature Pt100/1,000								
Operating range	-200 °C to +800 °C							
Accuracy	0.1 %							
Other functions								
MAX / MIN / AVG or PEAK +/-	On all the main positions measured							
Δ REL	REL relative value + secondary display with measured reference value							
PWM filter	300 Hz 4th-order low-pass filter for measurements on variable speed drives of asynchronous motors							
Clamp function V output with direct reading	Integration of ratio: 1/1, 1/10, 1/100, 1/1,000 mV/A							
Secondary functions	dBm and resistive power in VA, +/- duty cycle and pulse width							
Central zero	Selectable or automatic for V _{DC} and I _{DC}							
USB communication	With SX-DMM - SCPI commands							
General specifications								
Type of display	Transflective LCD with backlighting* and digits 14 mm high Double 60,000-count or 6,000-count display							
PC interfaces	USB optical socket - SX-DMM software							
Power supply	4 x AA batteries (or Ni-MH rechargeable batteries)							
Safety / EMC	Safety as per IEC61010-2-033 - 1000 V CAT III* / 600 V CAT IV - CEM as per EN61326-1							
Environment	Storage: -20 °C to +70 °C - Operation: -10 °C to +50 °C							
Mechanical specifications	Dimensions (L x W x H): 196 x 90 x 47.1 mm / Weight: 570 g							
Warranty	3 years							

(*) MTX3291 only

Standard state at delivery

Multimeter delivered with 4 x 1.5 V alkaline batteries, red straight/straight lead 1.5 m long, black straight/straight lead 1.5 m long, red CAT IV 1 kV test probe, black CAT IV 1 kV test probe, user manual on CD and startup guide on paper, USB cable and remote programming manual for communicating version

Specific accessories

HX0056-Z: optical/USB cable
MTX328X and MTX329X
HX0053: external NI-MH battery charger for MTX328X and MTX329X
HX0052B: transport kit for MTX329X
6,000 and 60,000 counts

References to order

MTX3290: DMM 6 kcts TRMS 20 kHz
MTX3291: DMM 60 kcts TRMS 100 kHz USB

Available accessories

See pages 97 to 106



For further details...

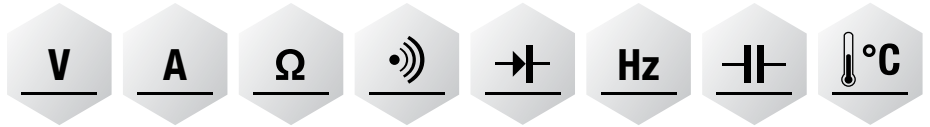

ASYC IV, the new tools from Metrix

2 portable multimeters with colour graphical display for direct measurement of the main electrical quantities: innovative design, compact, rugged, leakproof and easy to grip for all your measurements.

High-level multimeters...

- Colour 320 x 240-pixel liquid-crystal matrix screen with black background for easier reading
- Multi-parameter display: 1 main and 4 secondary measurements
- 4 x 100,000-count display and TRMS AC+DC converter
- 1,000 V CAT III protection
- Bandwidth: 100 kHz to 200 kHz
- Voltage measurement up to 1,000 V
- Current measurement up to 10 A (20 A for 30 s)
- Resistance measurement up to 50 MΩ
- Capacitance measurement up to 10 mF
- Frequency measurement up to 5 MHz
- K/J thermocouple or Pt temperature measurement from -200 °C to +1,200 °C
- Current measurement using clamp with direct reading (integration of ratio)
- Numerous additional measurement functions: low-pass PWM filter (variable speed drive), and V_{LowZ} low impedance measurement (500 k), dB/dBm measurement, duty cycle, pulses, diode measurements: Zener or LED, etc.
- A "reference" multimeter with its 100 kcounts and display of its specifications associated with a RELative mode



High-performance graphical multimeters...

- Graphical display of the trends on an overview screen
- Recall of traces, cursors and zoom on recordings

Dynamic loggers for capturing faults...

- Up to 6,500 measurements stored in memory
- Simplified definition of the number of measurements, the interval (1 s to 24 h), the duration and the memory capacity
- Internal storage of 10 measurement sequences
- Interactive zoom function on the recordings
- In addition, a simple monitoring mode displaying the time/date-stamped Min / Max and Avg values



...And much more!

- Contextual reminder of connections
- Classic USB communication or Bluetooth available as an option; the SX-DMM software can be used for real-time processing of the data on a PC, instrument upgrades and instrument calibration, with new functions: automatic time adjustment and display of available memory capacity
- Rechargeable Ni-MH AA battery with low self-discharge, the best solution in terms of quality and price: 4-level indication of battery capacity + %
- Battery life of up to 100 hours with management of the level
- No time wasted: the instrument operates while it is charging
- Developed and manufactured in France
- IP67 ingress protection: waterproof and dustproof, ideal for outdoor conditions

Technical specifications	MTX 3292				MTX 3293			
Length of scale								
Range	100 mV*		1,000 mV	10 V	100 V	1,000 V		
Resolution	1 μ V		10 μ V	0.1 mV	1 mV	10 mV		
DC accuracy	0.03 %				0.02 %			
AC and AC+DC bandwidth	100 kHz				200 kHz			
AC and AC+DC basic accuracy	0.3 %				0.3 %			
VLowZ AC	500 k Ω							
DC. AC and AC+DC current								
Range	1,000 μ A	10 mA	100 mA	1,000 mA	10 A	10 A / 20 A (30 s max)		
Resolution	10 nA	0.1 μ A	1 μ A	10 μ A	100 μ A	1,000 μ A		
DC accuracy	0.01 %							
AC and AC+DC bandwidth	50 kHz							
AC and AC+DC basic accuracy	0.3 %							
Frequency								
Frequency range	10 Hz	100 Hz	1 kHz	10 kHz	100 kHz	1 MHz	5 MHz	
Resolution	0.0001 Hz	0.001 Hz	0.01 Hz	0.1 Hz	1 Hz	10 Hz	100 Hz	
Resistance and continuity								
Ranges	100 Ω *	1 k Ω	100 k Ω	1,000 k Ω	10 M Ω	50 M Ω		
Resolution	0.001 Ω	10 m Ω	100 k Ω	10 Ω	10 Ω	1 k Ω		
Basic accuracy	0.07 %							
Protection	1,000 V electronic protection							
Audible continuity detection	1,000 Ω calibre: SIGNAL <20 Ω < 3.5 V							
Diode test								
Voltage measurement	2.6 V diode < 1 mA + 0-20 V Zener diode or LED < 11 mA							
Capacitance								
Ranges	1 nF	10 nF	100 nF	1,000 nF	10 μ F	100 μ F	1 mF	10 mF
Resolution	1 pF	10 pF	0.1 nF	1 nF	0.01 μ F	0.1 μ F	1 μ F	10 μ F
Temperature Pt100/1,000								
Operating range	-200 $^{\circ}$ C to +800 $^{\circ}$ C with Pt and -40 $^{\circ}$ C to +1,200 $^{\circ}$ C with K thermocouple							
Accuracy	0.1 %							
Other measurement functions								
SURV MAX / MIN / AVG	On all the main positions measured							
REL	REF relative value - delta unit or on 3 displays + main measurement							
PWM filter	300 Hz 4th-order low-pass filter for measurements on variable speed drives of asynchronous motors							
SPEC	Display of measurement tolerance + Smin + Smax							
GRAPH	Trend of main measurement < 60 s							
Secondary measurements	3 measurements + main measurement							
Measurement storage	1,000				6,500			
General specifications								
Type of display	Colour graphical display (70 x 52) with backlighting and black background on 4 x 100,000-count displays							
PC interfaces	USB optical connector or Bluetooth - SX-DMM software							
Power supply	Charger or 4 x AA batteries (or Ni-MH rechargeable batteries)							
Safety / EMC	Safety as per IEC61010-1 (2001) 1,000 V CAT III - EMC as per EN61326-1 CEI 61010-2-033 - 1000 V CAT III - 600 V CAT IV							
Environment	Storage: -20 $^{\circ}$ C to +70 $^{\circ}$ C - Operation: -10 $^{\circ}$ C to +40 $^{\circ}$ C							
Mechanical specifications	Dimensions (L x W x H): 196 x 90 x 47,1 mm / Weight: 570 g							
Warranty	3 years							

* Manual access

Standard state at delivery

Multimeter delivered in screen-printed box with 4 x NI-MH 2400 mAh 1.5 V rechargeable batteries, red straight/straight lead 1.5 m long, black straight/straight lead 1.5 m long, red CAT IV 1 kV test probe, black CAT IV 1 kV test probe, USB optical cable + SX-DMM software, user manual on CD and startup guide on paper

**References to order**

MTX3292: DMM graph TRMS 100 Kcts Colour 100 kHz USB
 MTX3292-BT: DMM graph TRMS 100 Kcts Colour 100 kHz BLUETOOTH
 MTX3293: DMM graph TRMS 100 Kcts Colour 200 kHz USB
 MTX3293-BT: DMM graph TRMS 100 Kcts Colour 200 kHz BLUETOOTH

Available accessories

See pages 97 to 106



For further details...



Selection guide

Clamps for digital multimeters

To avoid powering down the circuit, you are advised to measure the current with a current clamp with A or V output. The direct measurement function is implemented on the ASYC multimeters (Ax function).

As the clamp function integrates a precise ratio $xxxx.XA/xxxx.XV$ or XA , it is possible to connect a wide range of current clamps which you can find in the CHAUVIN ARNOUX Catalogue and on pages 96 to 101 of this document; however, you should check the input/output range of the clamp to ensure that it is compatible with the calibres offered by the multimeter.

The accuracy of this "clamp" function depends on the accuracy of the clamp and of the calibre or range used on the multimeter.



K2



Mini 02



Mini 03



Mini 05



Mini 09

General purpose	AC current							
Products	MINIO2	MINIO3	MINIO4	MINIO5	MINIO6	MINIO7	MINIO8	MINIO9
References	P01105102Z	P01105105Z	P01120401/02	P01120415	P01120304/05	P01120560	P01120561	P01120504
Useful measurement range with the multimeter for use from 5 % to 100 % of the multimeter ranges								
MX24	2.5 A to 50 A	25 mA to 100 A	2.5 A to 50 A		25 A to 1,200 A	0.5 A to 300 A	0.5 A to 3,000 A	0.5 A to 2,000 A
MX24B	25 A to 100 A		12 A to 240 A					
Clamp performance								
Bandwidth	10 kHz	500 Hz	10 kHz	10 kHz	10 kHz	20 kHz	20 kHz	20 kHz
Typical accuracy	1 %	3 % - 2 %	1 %	2 %	0.50 %	1 %	1 %	1 %
Clamping diam.	12 mm	12 mm	20 mm	20 mm	52 mm	54 mm	80 mm	140 mm
Output								
Direct readings	Yes 1 mA/A	Yes 1 mV/mA - 1 mV/A	Yes 1 mA/A	Yes 100 mV/A	Yes 1 mV/A	No 100 mV/A - 10 mV/A	Yes 10 mV/A - 1 mV/A	Yes 10 mV/A - 1 mV/A
Connection	Lead	Lead	Sockets/lead	Lead	Sockets/lead	Casing, 19 mm spacing		

General purpose	AC & DC current			Leakage current	Process	Current transformer
Products	E6N	PAC11	PAC20	MN73	K2	MN71
References	P01120040A	P01120068	P01120071	P01120421	P01120074A	P01120420
Useful measurement range with the multimeter for use from 5 % to 100 % of the multimeter ranges						
MX24 / MX24B	25 mA - 80 Aac/dc	0.4 A to 600 Aac 0.2 A to 400 Aac	25 A to 1,400 Aac 25 A to 1,000 Aac	25 mA to 240 Aac 25 mA to 240 Aac	2.5 mA to 450 mAac 2.5 mA to 300 mA _{RMS}	250 mA to 12 A
Clamp performance						
Bandwidth	2 kHz or 8 kHz	10 kHz	5 kHz	10 kHz	1.5 kHz	10 kHz
Typical accuracy	2 % or 4 %	1.5 % - 2 %	2 %	1 % - 2 %	1 %	1 %
Clamping diam.	11.8 mm	39 mm	39 mm	20 mm	3.9 mm	20 mm
Output						
Direct readings	Yes 1 V/A - 10 mV/A	Yes 10 mV/A - 1 mV/A	Yes 1 mV/A	Yes 1 V/A - 10 mV/A	No 10 mV/A	No 100 mV/A
Connection	Lead	Lead	Lead	Lead	Lead	Lead

On the ASYC IV MULTIMETERS, the CLAMP function integrates the transformation ratio in mV or mA/A according to the coupling selected. The measurement range of clamp will be adapted to match the measurement range of the multimeter.

MTX3290 and MTX3291 fixed ratios: 1/1-1/10-1/100-1/1,000 mV/A

List of the main clamps in our CHAUVIN ARNOUX range:



MN 08



MN 09



PAC 11



PAC 20



MAT10 (MiniFlex*)



A110 (AmpFlex*)

General purpose	AC current							
Products	MINI02	MINI05	MN08/09	MN89	C106/C107	MiniFLEX®	MiniFLEX®	AmpFLEX®
References	P01105102Z	P01105105Z	P01120401/02	P01120415	P01120304/05	P01120560	P01120561	P01120504
Useful measurement range with the multimeter for use from 5 % to 100 % of the multimeter ranges								
MTX 3290 / MTX 3291	200 mA to 100 A	6 mA to 100 A	0.6 to 240 A	0.6 A to 240 A	6 A to 1,200 A	0.5 A to 300 A	0.5 A to 3,000 A	0.5 A to 2,000 A
MTX 3292 / MTX 3293	50 mA to 100 A	5 mA to 100 A	0.5 to 240 A	0.5 A to 240 A	1 A to 1,200 A	0.5 A to 300 A	0.5 A to 3,000 A	0.5 A to 2,000 A
Clamp performance								
Bandwidth	10 kHz	500 Hz	10 kHz	10 kHz	10 kHz	20 kHz	20 kHz	20 kHz
Typical accuracy	1 %	3 % - 2 %	1 %	2 %	0.50 %	1 %	1 %	1 %
Clamping diam.	12 mm	12 mm	20 mm	20 mm	52 mm	54 mm	80 mm	140 mm
Output								
Direct readings	Yes 1 mA/A	Yes 1 mV/mA - 1 mV/A	Yes 1 mA/A	Yes 100 mV/A	Yes 1 mV/A	No 100 mV/A - 10 mV/A	Yes 10 mV/A - 1 mV/A	Yes 10 mV/A - 1 mV/A
Connection	Lead	Lead	Sockets/lead	Lead	Sockets/lead	Casing, 19 mm spacing		

General purpose	AC & DC current			Leakage current	Process	Current transformer
Products	E6N	PAC11	PAC20	MN73	K2	MN71
References	P01120040A	P01120068	P01120071	P01120421	P01120074A	P01120420
Useful measurement range with the multimeter for use from 5 % to 100 % of the multimeter ranges						
MTX 3290 / MTX 3291	6 mA to 80 A	60 mA to 600 A	6 A to 1,400 A 1,000 Aac	60 mA to 240 A	6 mA to 450 mA 6 mA to 3.3 Aac	60 mA to 12 A
MTX 3292 / MTX 3293	5 mA to 80 A	10 mA to 600 A 1 A to 400 Aac	1 A to 1,400 A 1 A to 1,000 Aac	10 mA to 240 A	1 mA to 450 mA 1 mA to 300 mAac	10 mA to 12 A
Clamp performance						
Bandwidth	2 kHz or 8 kHz	10 kHz	5 kHz	10 kHz	1.5 kHz	10 kHz
Typical accuracy	2 % or 4 %	1.5 % - 2 %	2 %	1 % - 2 %	1 %	1 %
Clamping diam.	11.8 mm	39 mm	39 mm	20 mm	3.9 mm	20 mm
Output						
Direct readings	Yes 1 V/A - 10 mV/A	Yes 10 mV/A - 1 mV/A	Yes 1 mV/A	Yes 1 V/A - 10 mV/A	No 10 mV/A	No 100 mV/A
Connection	Lead	Lead	Lead	Lead	Lead	Lead



MX 5006 & MX 5060

A tried and tested casing



MX5006

Lightweight and compact

Multidirectional handle for positioning as you wish. A casing which can be stacked on your lab bench to save space.

The mains lead can be wound round the "feet" for easy storage.

A display (890 x 450 mm)

Optimized over the whole height of the casing to offer comfortable reading with 16 mm digits on the main display above a second simultaneous display. The transfective LCD screen with backlighting provides a wider viewing angle making it visible whatever the conditions.

A double 60,000-count display plus an analogue view by means of a bargraph.

Top performance

0.05 % accuracy and AC, DC or AC+DC TRMS measurements, as required, as well as AUTO or manual ranges to optimize your measurements.

Extended functions

Equipped with all the traditional functions (voltage, current, resistance, continuity, diode test), these multimeters also offer extended functions: measurement of capacitance, frequency, period and Δ REL relative. Values expressed as values and in %.

Measurements in total safety for electrical engineering applications with 1,000 V CAT III protection: a V_{LowZ} low input impedance mode for stable measurements by eliminating "stray" voltages plus a PWM filter selectable for your measurements on variable speed drives (asynchronous motors).

Monitoring of your measurements with MIN / MAX (100 ms) / PEAK (1 ms) recordings to capture any faults.

The 3 terminals limit handling errors with complete current autoranging from 50 μ to 20 A. The **MX 5060** is equipped with a USB interface for remote programming and processing of the data by our SX-DMM software for multimeters.

A simple, precise mechanical switch for selecting the main quantity and a secondary function key marked in colour.

METRIX benchtop multimeters: laboratory instrumentation reinvented

Simple and effective.

- A compact, lightweight casing
- A particularly easy-to-read display with widened viewing angle and digits 16 mm high
- Current measurement with a single current terminal up to 10 A
- MX5060: USB communication and programming with the SCPI protocol



Specifications	MX5006	MX5060
Resolution	6,000 counts	60,000 counts
Display	Transflective LCD Backlighting Widened viewing angle	
DC, AC and AC+DC TRMS voltage		
Ranges	600 mV to 1,000 V	60 mV to 1,000 V
DC basic accuracy	0.09 %	0.05 %
Useful bandwidth	100 kHz	
DC, AC and AC+DC current		
Ranges	6,000 μ A to 10 A (20 A 30 s)	
AC and AC+DC basic accuracy	1 %	
DC basic accuracy	0.80 %	
Frequency measurements		
Ranges	60 Hz to 60 kHz	
Other measurements	Period PWM filter	
Resistance and continuity		
Ranges	600 Ω to 60 M Ω	
Basic accuracy	0.40 %	0.20 %
Audible continuity test	600 Ω range - threshold < 30 Ω	
Diode test	0 to 3 V	
Capacitance	6 nF to 60 mF	
Temperature with K thermocouple	-200 to +1,200 $^{\circ}$ C	
Communication	USB	
Other measurements	SURV (MIN/MAX) and Peak +/- / Δ REL	
Additional functions	HOLD and AUTO 300 Hz filter	
IEC61010-1 safety	1,000 V CAT III	
Dimensions (H x L x W) / Weight	295 x 270 x 95 mm / 1.85 kg	
Warranty	3 years	



MX5060

Standard state at delivery

1 MX: 1 mains power cable, 1 set of 2 measurement leads, 1 user manual

Available accessories

See pages 97 to 106

References to order

MX5006: 6,000-count benchtop TRMS multimeter

MX5060: 60,000-count benchtop TRMS USB multimeter



For further details...

Software

SX-DMM

PC data acquisition software for multimeters

This data acquisition software can be used to link up to 4 controllable multimeters, whether they are on-site or benchtop models.



List of controllable multimeters

- MX 26, MX 53, MX 54, MX 56, MX 57, MX 58, MX 59
- MX 554, MX 556, MX 5060
- MTX 3250
- MTX 3281, MTX 3282, MTX 3283
- MTX 3291, MTX 3292, MTX 3293



This software can be used to communicate with our multimeters via an RS232, USB or BLUETOOTH link, depending on the model: This software can be used to communicate with our multimeters via an RS232, USB or BLUETOOTH link, depending on the model:

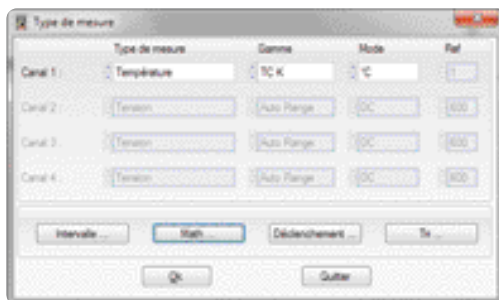
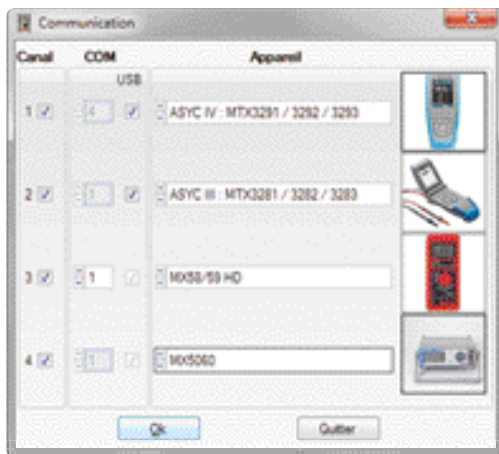

SX-DMM, the software for acquiring, recording and processing the measurements from 1 to 4 multimeters simultaneously. Each channel must be assigned to a COM or USB serial port for connection to be possible. Several SX-DMM sessions can be opened at the same time on a PC.

The trigger mode and acquisition intervals can be set from 100 ms upwards and the clock can be managed automatically, depending on the model.

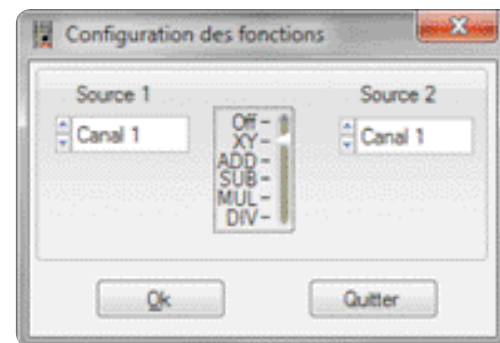

⊕ The Math functions: XY, differential, integral, curve smoothing

⊕ Data export into EXCEL for processing in a spreadsheet

This software transforms your multimeter(s) into a power monitor with up to 4 channels for point testing

Reference to order

SX-DMM2: software for multimeters

Metrology software

SX-ASYC2C/B MX 57EX-CAL & HX 0059

The various versions of this software help you to perform periodic testing and/or calibration of your instruments with the "casing closed" via their RS or USB serial communication interface (depending on the model), simply and effectively.

Without needing to research the technical details of the instrument, users can execute "manufacturer" procedures or develop their own procedures, in compliance with the Quality monitoring standards, while ensuring in particular the reverse traceability of their processes, saving their data and printing out reports.

List of multimeters supported and associated software

- MX53, MX54, MX55, MX56, MX58, MX59 **SX-ASYC2C/B**
- MX57 **MX57EX-CAL**
- MTX328X, MTX3292 and MTX3293 **HX0059**
- MTX3291 and MX5060 (after opening the casing)
offer a calibration kit P01196770

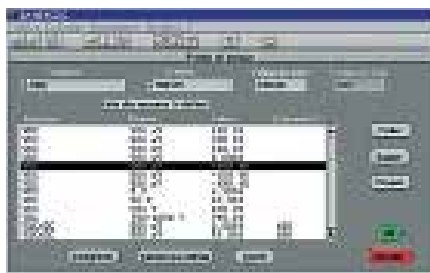

Creation/modification of procedures

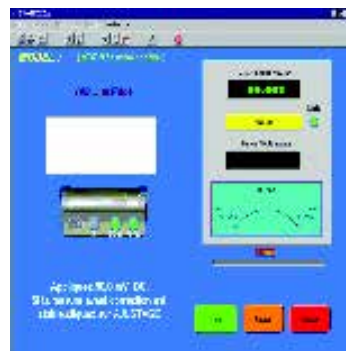

Execution of the procedure and instructions for the operator



Regulatory and connection information

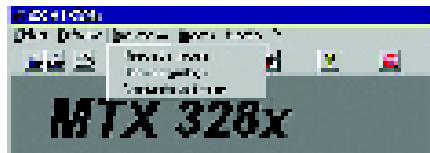

Saving and/or printing of reports





Communication accessories and software

	Description	References to order
Multimeters		
MX 58HD, MX 59HD	Serial link kit for ASYC2 HD version Acquisition software for ASYC2	SX-ASYC2HD SX-DMM2
MX 58HD, MX 59HD	ASYC2 family calibration software	SX-ASYC2C/B
MX 57Ex	MX 57Ex calibration software	MX57EX-CAL
MTX 3281, MTX 3282, MTX 3283, MTX 329X	MTX 328X V1.0 calibration software Optical / USB cable Bluetooth / USB adapter for PC Communication kit with software	HX0059 HX0056-Z P01637301 HX0050
MX 55, MX 556	Calibration software for MX 553 & MX 556 Software for MX 553 & MX 556	SX-ASYC2C/B SX-DMMBT/B
MX 5060	USB A-USB B cable	P01295293
MTX 3292, MTX 3293	ASYC4 100K calibration software	HX0059B
MTX 3291, MX 5060	"Open casing" calibration kit	P01196770
All models	USB/RS232 adapter for PC	HX0055

- The common software for all METRIX® multimeters: **SX-DMM2**
- Instrument drivers for LabView and LabWindows CVI
The multimeters are available in the Support section of our website, as are the USB drivers of our accessories: HX0055 and HX0056

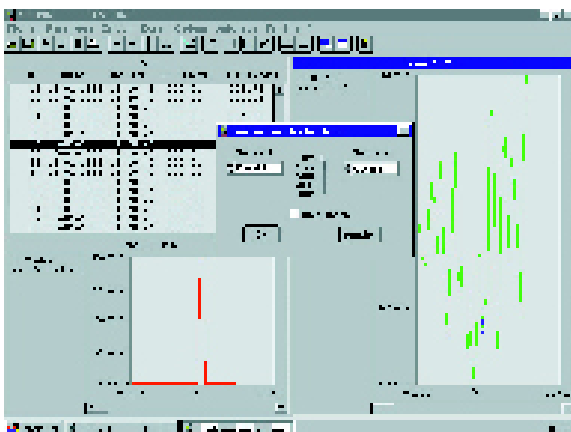
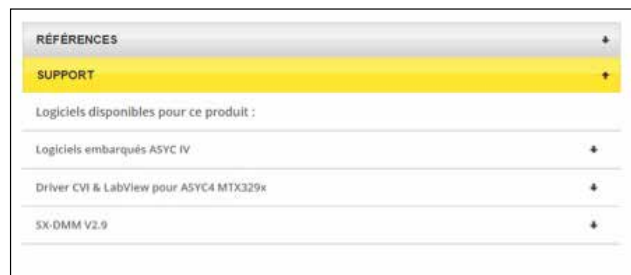

The multilingual SX-DMM2 communication kit is easy to use with the MX 26 for data acquisition on PC

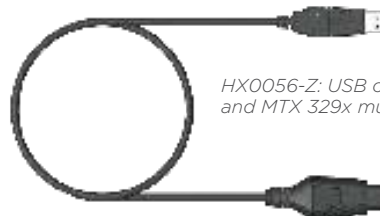

HX0056-Z: USB cable for MTX 328x and MTX 329x multimeters

Selection guide



Specifications	MX 350	MX 355	MX 650	MX 655	MX 670	MX 675
AC current	•	•	•	•	•	•
DC current		•		•		•
RMS/TRMS measurement				•	•	•
Clamping ø 26 mm	•					
Clamping ø 30 mm		•				
Clamping ø 36 mm			•			
Clamping ø 40 mm				•		•
Clamping ø 42 mm					•	
4,000-count display	•	•	•	•		
10,000-count display					2	2
Backlighting					•	•
Bargraph	•	•	•	•		
AC current	400 A	400 A	1,000 A	1,000 A	1,000 A	1,000 A
DC current		400 A		1,000 A		1,400 A
AC voltage	600 V	600 V	750 V	750 V	1,000 V	1,000 V
DC voltage	600 V	600 V	1,000 V	1,000 V	1,400 V	1,400 V
Resistance	•	•	•	•	•	•
Audible continuity	•	•	•	•	•	•
Diode and semi-conductor tests			•	•		
Frequency	•		•	•	•	•
Temperature					•	•
Hold	•	•	•	•	•	•
ΔZero or ΔREL		•	•	•		•
Min / Max / Peak			• / • / •	• / • / •	• / • / •	• / • / •
Range		•	•			
Automatic power-off	•	•	•	•	•	•
300 V CAT III	•	•				
600 V CAT III			•	•		
1,000 V CAT III					•	•
600 V CAT IV					•	•
Pages	36	36	37	37	38	38

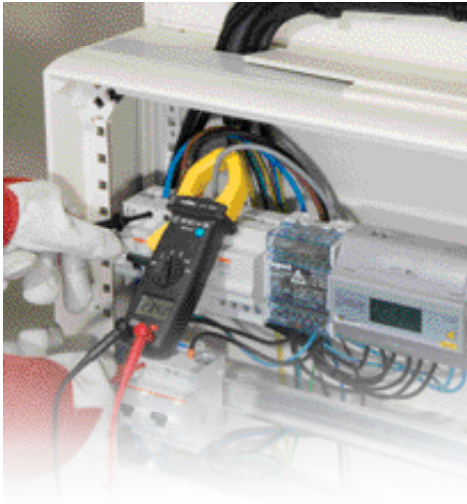

MX 350 & MX 355

Comprehensive: all the functions needed by electricians in one hand.

- Compact, ergonomic clamp multimeters
- Current measurement up to 400 AAC (MX 350) or 1,000 AAC and 1,000 AAC&DC (MX 355)
- AC & DC voltage measurement up to 600 V
- Resistance and continuity measurement
- Frequency measurement (MX 350)
- Automatic zero DC (MX 355)
- LCD screen with bargraph



Specifications	MX 350	MX 355
Display	4,000 counts	
Bargraph	42 segments	
Clamping diameter	26 mm	30 mm
Type of acquisition	AVG	
Range selection	Automatic	Automatic or Manual
AC current	0.05 A to 400.0 A	
Basic accuracy	1.9 % +5 D	2% of reading + 10 D
Bandwidth	50 to 500 Hz	
DC current	-	0.1 A to 400 A
Basic accuracy	-	2.5% of reading + 10 D
AC voltage	0.5 V to 600 V	
Basic accuracy	1.5% of reading + 5 D	
Bandwidth	50 to 500 Hz	
DC voltage	0.2 V to 600 V	
Basic accuracy	1% of reading + 2 D	
Resistance	0.2 to 399.9 Ω	
Basic accuracy	1% of reading + 2D	
Audible continuity	≤ 40 Ω	
Frequency	Current: 20 Hz to 10.00 kHz Voltage: 2 Hz to 1 MHz	
Basic accuracy	0.1% of reading + 1D	
Fonctions	Hold	Hold ΔZero Range
Automatic shutdown	30 min.	30 min., can be deactivated
Power supply	2 x 1.5 V (AAA)	
Electrical safety	CAT III 300V / CAT II 600V	
Dimensions / Weight	193 x 50 x 28 mm / 230 g	

Standard state at delivery

1 MX 35x clamp multimeter delivered with 1 set of measurement leads with test probes, 1 soft case, 2 x 1.5 V AAA alkaline batteries and 1 user manual in 5 languages

References to order

MX0350-Z: 1 MX 350 clamp
MX0355-Z: 1 MX 355 clamp

Available accessories

See pages 97 to 106



1,000 A CLAMP MULTIMETERS



MX 650 & MX 655

Suitable for maintenance of electric machines.

- Clamps for measuring high currents and voltages
- Current measurement up to 1,000 A_{AC} (MX 650) or 1,000 A_{AC} and 1,000 A_{AC&DC} (MX 655)
- AC & DC voltage measurement up to 1,000 V
- Resistance, continuity and frequency measurements
- RMS measurements (MX 655)
- Min-Max and Peak 1 ms analytical functions
- Differential current, voltage and resistance measurements

Specifications	MX 650	MX 655
Display	4,000 counts	
Bargraph	42 segments	
Clamping diameter	36 mm	40 mm
Type of acquisition	AVG	
Range selection	Automatic or manual	Automatic
AC current	0.05 A to 1,000 A	
Basic accuracy	1.9% of reading + 5 D	
Bandwidth	50 Hz to 1 kHz	
DC current	-	0.10 A to 1,000 A
Basic accuracy	-	2.5% of reading + 10 D
AC voltage	0.5 V to 750 V	
Basic accuracy	2.5% of reading + 10D	
Bandwidth	50 Hz to 1 kHz	
DC voltage	0.2 V to 1,000 V	
Basic accuracy	0.75% of reading + 2 D	1% of reading + 2 D
Resistance	0.2 to 4,000 Ω	
Basic accuracy	1% of reading + 2 D	
Audible continuity	≤ 100 Ω	
Diode test and semi-conductor junction test	$I_{test} \leq 0.6 \text{ mA} / V_{test} \leq 3.3 \text{ VDC}$	$I_{test} \leq 1.7 \text{ mA} / V_{test} \leq 6 \text{ VDC}$
Frequency	Current: 20 Hz to 10 kHz Voltage: 10 Hz to 10 kHz	
Basic accuracy	0.1% of reading + 1 D	
Functions	Hold. Peak (1 ms). Max-Min. ΔREL. Range	Hold. Peak (1 ms). Max-Min. ΔREL
Automatic shutdown	30 min., can be deactivated	
Power supply	1 x 9 V 6LF22 battery	
Electrical safety	IEC 61010-1, IEC 61010-2-032, IEC 61010-2-033 - 600_V CAT III	
Dimensions / Weight	246 x 93 x 43 mm / 400 g	



CLAMP MULTIMETERS



Standard state at delivery

1 MX 65x clamp multimeter delivered with 1 set of measurement leads with test probes, 1 soft case, 1 x 9 V alkaline battery and 1 user manual in 5 languages

Available accessories

See pages 97 to 106

References to order

MX0650-Z: 1 MX 650
MX0655-Z: 1 MX 655



For further details...

DUAL-DISPLAY TRMS CLAMP MULTIMETERS



MX 670 & MX 675

Extra protection for industry and electrical power distribution.

- 2 simultaneous TRMS measurement channels
- Dual 10,000-count backlit display
- CAT IV 600 V
- Voltage up to 1,400 V
- Temperature measurement



Specifications	MX 670	MX 675
Clamping diameter	42 mm	40 mm
Display	2 x 10,000 counts / backlighting	
Type of acquisition	TRMS AC/DC	
Range selections	Automatic	
AC current	0.05 A to 1,000 A	
Basic accuracy	1.5 % of reading +5 D	
Bandwidth	50 Hz to 3 kHz	
DC current	0.10 A to 1,400 A	
Basic accuracy	1.2 % of reading +5 D	
AC voltage	0.5 V to 1,000 V	
Basic accuracy	1 % of reading +5 D	
Bandwidth	50 Hz to 3 kHz	
DC voltage	0.2 V to 1,400 V	
Basic accuracy	1 % of reading +2 D	
Resistance	0.2 to 9,999 Ω	
Basic accuracy	1% of reading + 3 D	
Audible continuity	≤ 35 Ω	
Temperature	-40.0 °C to +1,200 °C / -40 °F to +2,192 °F	
Basic accuracy	1% of reading + 3 D	
Frequency	Current: 0.2 Hz to 9,999 Hz Voltage: 10 Hz to 9,999 Hz	
Basic accuracy	1% of reading + 2 °C / 1% of reading + 4 °F	
Functions	Hold Peak (1 ms) Min (500 ms) Max (500 ms)	Hold Peak (1 ms) Min (500 ms) Max (500 ms) ΔZero
Automatic shutdown	10 min., can be deactivated	
Power supply	1 x 9 V 6LF22 battery	
Electrical safety	IEC 61010-1. IEC 61010-2-032. IEC 61010-2-033 600 V CAT IV / 1,000 V CAT III	
Dimensions / Weight	272 x 80 x 43 mm / 480 g	257 x 80 x 43 mm / 440 g

Standard state at delivery

1 MX 670 or MX 675 clamp multimeter delivered with 1 x 9 V alkaline battery, 1 user manual in 5 languages, 1 soft case, 1 set of leads with Ø 4 mm test probes and K-thermocouple sensor

References to order

MX 675: MX0675
MX 670: MX0670

Available accessories

See pages 97 to 106



For further details...

COS φ

V

A

W

VA

var

PX 110 & PX 120

Designed for general and technical education, installers and industrial maintenance teams, the PX 110 and PX 120 digital wattmeters can be used both on-site and in the laboratory.

PX 110

■ Single and three-phase TRMS digital wattmeter

PX 120

■ Single-phase TRMS digital wattmeter

Specifications	PX 110	PX 120
Network type	Single-phase	Single and three-phase
Number of display counts	3 lines of 4 digits	
Bandwidth	DC to 1 kHz	
AC/DC active power	6 kW	
Resolution	0.1 - 1 W	
AC/DC basic accuracy	2 % R ± 3 D	1 % R + 2 D
Apparent power (VA)	10 VA to 1 kVA	
Reactive power (var)	1 VAR to 6 kVAR	
Resolution	0.1 to 1	
AC/DC basic accuracy	2 % R ± 2 D	
Power factor	1	
Resolution	0.01 / 3 % R ± 2 D	
AC/DC voltage	500 mV to 600 V _{RMS}	
Resolution	100 mV	
AC/DC basic accuracy	1 % R ± 3 D	0.5 % R + 2 D
Current	10 mA to 10 ARMS	
Resolution	1 to 10 mA	
AC/DC basic accuracy	1 % R ± 3 D	0.5 % R + 2 D
Inrush current	5 to 65 A (peak)	
Resolution/accuracy	100 mA / 10 % R ± 2 D	
IEC 61010 safety	600 V, Cat. III, pol.2	
Interface and software	Yes - RS232 optical link (option)	
Auto power-off	After 10 minutes	
Power supply	6 x 1.5 V	
Dimensions	60 x 108 x 211 mm	
Weight	835 g	
Accessories supplied	2 current cables and 2 voltage cables, 2 test probes, 6 batteries and 1 user manual	

Accessories



HX 0011 wattmeter switch

This makes it possible to use the two wattmeter method with a single wattmeter. This allows measurements on unbalanced 3-wire 3-phase systems. The polarity reversal switch contains auxiliary contacts ensuring continuity of the current circuits during switching operations.

The following measurements are possible for frequencies of 50 to 60 Hz:

- AC voltages from 10 to 600 V,
- AC currents from 0 to 20 A



HX 0012 multi-ratio transformer

This can be used for measurements on loads whose power

consumption is higher than the specifications of the wattmeter used. The following measurements are possible for frequencies of 50 to 60 Hz:

- AC voltages from 10 to 600 V,
- AC currents from 0 to 30 A



Wattcom

Multilingual data acquisition and processing software for viewing different quantities on a PC screen, printing screenshots or transferring measurement files into a spreadsheet and storing them.

Accessories supplied with the Wattcom software

RS232 optical cable

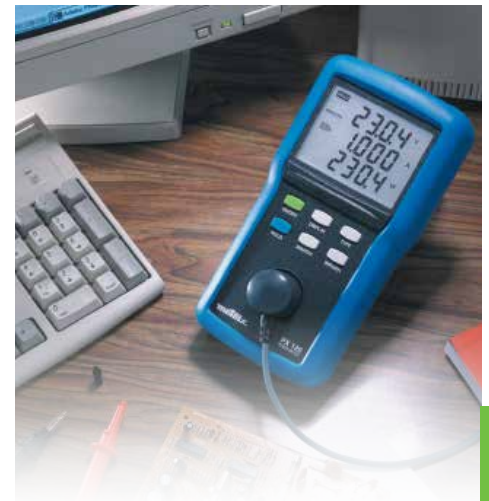

TESTERS

References to order

PX0110 : PX 110 wattmeter

PX0120: PX 120 wattmeter

HX0011: wattmeter switch

HX0012: multi-ratio transformer

HX0013: Wattcom software + RS232

cable

HX0021: PX 110 and PX 120 mains power supply

P01330401: USB cable

P03295509: accessory for current measurement



For further details...



Analogue voltmeter
and ammeter



MX125 & MX135

Designed to withstand mechanical shocks, protected by high-rupture-capacity fuses.

■ Equipped with a moving-coil galvanometer:

- Safety: IEC61010 - 600 V CAT III
- Ingress protection: IP65

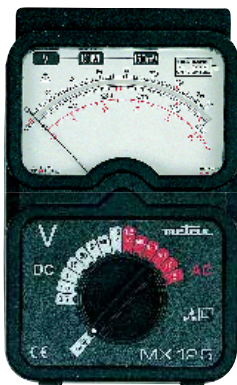

Specifications	MX125	MX135
Length of scale	83 mm	
Bandwidth	16 to 1 kHz	
Voltage	9 DC calibres (150 mV to 1,500 V) 6 AC calibres (5 mV to 1,500 V)	
Current		7 DC calibres (50 µA to 10 A) 6 AC calibres (500 µA to 10 A)
Ri	20 kΩ	
Dimensions / Weight	155 x 99 x 40 mm / 350 g	

Specifications	MX125
V _{dc}	Ranges 9 (150 mV, 0.5 V, 1.5 V, 5 V, 15 V, 50 V, 150 V, 500 V, 1,500 V) Accuracy 2 % Ri 20 kΩ/V
V _{ac}	Ranges (V) 6 (5, 15, 50, 150, 500, 1,500) Accuracy 2.5 % Ri 6.32 kΩ/V

Specifications	MX135
I _{dc}	Ranges 7 (50 µA, 500 µA, 5 mA, 150 mA, 500 mA, 1.5 A, 10 A) Accuracy 2 % Protection 10 A and 1.6 A fuses (HRC 600 V)
I _{ac}	Ri 1.2 kΩ Ranges (V) 6 (500 µA, 5 mA, 150 mA, 500 mA, 1.5 A, 10 A) Accuracy 2.5 % Protection 10 A and 1.6 A fuses (HRC 600 V)

Standard state at delivery

MX125: 1 MX voltmeter and user manual
MX135: 1 MX ammeter and user manual

References to order

MX125: MX125 voltmeter
MX135: MX135 ammeter

Available accessories

See pages 97 to 106

Electrical installation testing

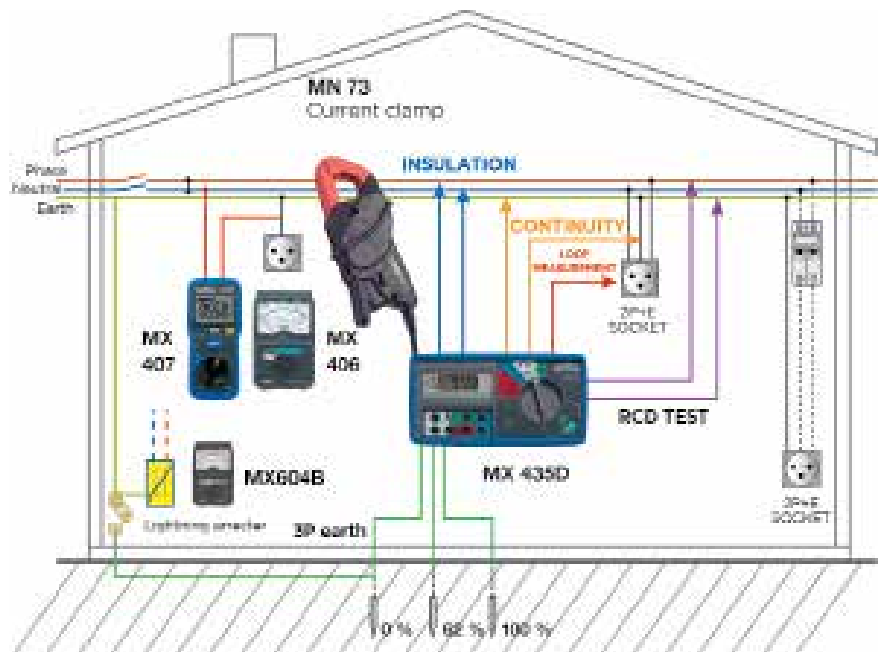

The purpose of electrical safety testing is to ensure the safety of people and property in the event of a fault on the installation. It can also be used for preventive maintenance, thus avoiding serious failures. To guarantee safety, the CENELEC HD 384 standard specifies the requirements applicable to electrical installations in buildings, with the following measurements in particular:

Earth measurement with stakes

The earth stake must have a resistance lower than 100Ω to allow any faults to drain to earth. When there is sufficient room to set up stakes, this measurement can be performed using the 3P method with stakes, also known as the "62 % method". The earth bar must be disconnected during this measurement.

Earth measurement without stakes by measuring the earth loop

When the 62 % method is not applicable, you can use the stakeless method which involves measuring the earth loop. This measurement can be performed on live installations and does not require any stakes. This method provides an overall value rounded up from the real earth value.

Continuity measurement

The continuity of the protective conductors is measured with a test current of at least 200 mA. The resistance measured must be below a threshold which is usually 2Ω .

Insulation measurement

Insulation measurement, usually performed between active conductors and the earth, involves applying a 250 V, 500 V or 1,000 V_{DC} test voltage, depending on the operating voltage of the installation. The insulation resistance value must be at least $1 \text{ k}\Omega$ per volt of the test voltage (usually $500 \text{ k}\Omega / 1 \text{ M}\Omega$).

Residual Current Device testing

At least one pulse-mode trip test must be performed on the RCDs on the installation to check the trip time.

Other test and measurement operations

Current measurement using a clamp coupled to an installation tester helps to detect existing leakage, as well as possible phase unbalance on three-phase installations.

You are also advised to test the lightning arresters to ensure that they will do their job in the event of a voltage surge due to lightning on the installation.

Analogue insulation tester



MX 406B

- Insulation measurement at 50, 250 and 500 V_{DC}
- Voltage measurement up to 440 V_{AC/DC}
- Continuity (200 mA)
- Quick and easy readings with the colour-scale dial
- Hands-free use with remote control probe

Specifications	MX 406B
Insulation	10 kΩ to 200 MΩ at 50/250 and 500 V _{DC} (3 ranges)
Continuity with buzzer	0 to 10 Ω (i > 200 mA _{DC})
Voltage	0 to 440 V _{AC/DC}
Electrical safety	IEC 1010 - 300 V CAT III
Power supply	3 x 1.5 V batteries for 1,000 x 5 s measurements
Dimension / Weight	155 x 98 x 40 mm / 410 g

Standard state at delivery

MX406B: 1 MX 406B tester delivered with 1 remote-control probe, 1 black safety lead, 1 black crocodile clip, 3 x 1.5 V batteries and 1 user manual

Reference to order

MX0406B: 1 MX 406B tester



Insulation tester

MX 604

Lightning arrester tester.

- Lightning-arrester support module for measurements on unmounted lightning arresters
- Probe with remote-control button for in-situ measurements
- Measures insulation resistance at 50, 100 and 500 V_{DC}
- Quick and easy readings with the colour-scale dial

Specifications	MX 604
Lighting arrester test	0 to 600 V _{DC}
Insulation	100 kΩ to 2,000 MΩ at 50/100 and 500 V _{DC} (3 ranges)
Battery test	Yes
Electrical safety	IEC 1010 - 300 V CAT III
Power supply	3 x 1.5 V batteries for 1,500 x 5 s measurements
Dimension / Weight	155 x 98 x 40 mm / 350 g

Standard state at delivery

1 MX 604 delivered in a hard case with 1 detachable lightning-arrester support module, 1 remote-control probe, 1 red test probe, 1 black straight-straight lead 1.5 m long with built-in test probe, 1 black crocodile clip, 1 lightning-arrester support clamp, 1 strap mounted on the instrument, 3 batteries, 1 user manual in 5 languages

Reference to order

MX0604: 1 MX 604 tester

Available accessories

See pages 97 to 106



For further details...

Insulation tester

MX 407



With the MX 407, you get two tools in one as it is a megohmmeter equipped with all the functions of a multimeter as well.

- Insulation at 250 / 500 / 1,000 V
- AC or DC voltage measurement up to 600 V
- Insulation resistance up to 4 GΩ
- Continuity with 200 mA test current
- Dual analogue and digital display on wide backlit screen



Specifications		MX 407
Voltage		
Range		0 to 600 V _{AC/DC}
Accuracy		±0.8 % ± 3 cts (DC) ±1.2 % ± 10 cts (AC)
Insulation		
Test voltage	250 V	10 kΩ to 4 GΩ
	500 V	10 kΩ to 4 GΩ
	1,000 V	10 kΩ to 4 GΩ
Accuracy	Range 4 MΩ/40 MΩ	±2 % ±10 cts
	Range 400 MΩ	±2 % ±5 cts
	Range 4 GΩ	±4 % ±5 cts
Voltage alert indicator		Yes > 25 V
Test inhibition		Yes > 25 V
Continuity		
Range		0 to 400 Ω
Measurement current		> 200 mA
Cable compensation		Yes
Buzzer		Buzzer triggered if < 35 Ω ± 3 Ω
Resistance		
Range		0 to 400 kΩ
Accuracy		±1.2 % ± 3 cts
Automatic power-off		After 10 minutes without use
Display / Backlighting		LCD + bargraph / Yes
Power supply		6 x 1.5 V AA batteries
Electrical safety		IEC 61010 600 V CAT IV // IEC 61557-3-4
Dimensions / Weight		H 200 x L 92 x W 50 mm / 700 g (with batteries)



Standard state at delivery

1 MX 407 insulation tester delivered in "hands-free" bag with 1 set of leads 1.5 m long (red/black), 1 black test probe, 1 red crocodile clip, 6 x 1.5 V AA batteries and 1 user manual in 5 languages



Reference to order

MX0407: 1 MX 407 tester

Available accessories

See pages 97 to 106



For further details...



Multi-function installation tester



MX 435D

Quick, simple testing of electrical installations in compliance with the CENELEC HD 384 (NF C 15-100) standard.

- Compact and lightweight, ideal for intensive use
- Earth measurement without stakes by measuring the earth loop
- 3-wire lead with 2P+E plug for quick, error-free measurement on the installation
- Powered by rechargeable battery (batteries and charger supplied)
- Immediate error-free connection thanks to colour-coding of the terminals and the switch
- Continuity with buzzer and fuseless protection against external voltages



Standard state at delivery

1 MX 435D delivered in a hands-free bag, 1 set of 2 measurement leads 1.5 m long (red/black), 2 crocodile clips (red/black), 2 test probes (red/black), 1 battery charger, 1 measurement lead with European mains plug and 1 user manual

Specific accessories

Continuity rod P01102084A
 Adapter for MX435D loop measurement HX0092
 MN73 200 AAC / 2 AAC current clamp P01120421
 Earth kit:
 15 m basic earth kit P01102019
 50 m earth kit P01102021

Reference to order

MX0435D



The complete 50 m earth kit



For further details...

Available accessories

See pages 97 to 106



Specifications		MX 435D
Voltage		0 to 600 V _{AC}
3P earth		0.10 to 1,999 Ω (2 calibres)
Earth loop		0.10 to 1,999 Ω (2 calibres)
Continuity + buzzer		0.10 to 19.99 Ω (i > 200 mA _{DC})
Insulation		0.5 to 199.9 MΩ at 500 V _{DC}
RCD test		
Test calibres		30 mA / 100 mA / 300 mA / 500 mA / 650 mA
Type of test		Pulse
Current (with clamp option)		1 mA to 200 A
Electrical safety		IEC 1010 - 300 V CAT III - IEC 61557 1-2-4-5-6
Power supply		Rechargeable battery (as standard) Possibility of operation with 2 x 9 V batteries
Dimensions		195 x 97 x 55 mm
Weight		670 g

CHAUVIN ARNOUX: A CERTIFIED TRAINING ORGANIZATION SINCE 1993

CERTIFICATION No. 11.92.06217.92

The Chauvin Arnoux Group proposes six training modules, each lasting one day. Whether for theoretical training or hands-on practical sessions, you can trust the market leader to train you and your staff.

ELECTRICAL INSTALLATIONS AND NF C 15-100 STANDARD (1 day)

- Properties and goals of earth connection systems
- Behaviour of earth connection systems regarding harmonics
- Insulation resistance measurement
- Electrical continuity measurements on protective conductors
- Resistance measurements on earth connections
- RCD testing

www.chauvin-arnoux.com

www.chauvin-arnoux.com/fr/guides

Introduction

Analogue oscilloscope with cathode ray tube

This is an instrument for "qualitative analysis" which can be used to view the waveform of a periodic electrical signal as a function of time.

Block diagram of an oscilloscope

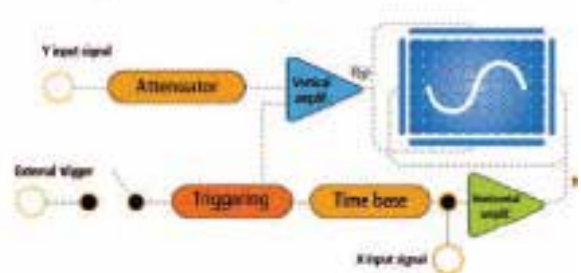

Choosing your analogue oscilloscope

Cathode ray tube

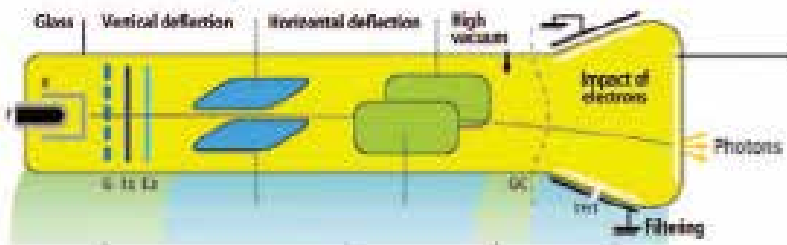

Vertical deflection

Deflection coefficient

This defines the minimum amplitude (sensitivity) and maximum amplitude values accepted by the input Y.

Bandwidth (BW)

This is the maximum admissible frequency range for the oscilloscope (MHz).

Rise time (rt)

For a square signal (steep edges), this is the time necessary for the rising edge to pass from 10 % to 90 % of the "peak to peak" amplitude.

Horizontal deflection

Time base (TB)

It is the oscilloscope's circuits which control the screen sweep. The choice of the "time base coefficient" enables the signals to be displayed over an appropriate duration.

Alternate or Chop display

Multiplexing of the channels allows display of

several channels, Y1, Y2, ... Y4, with a single electron beam. In alternate mode, each of the traces performs a complete sweep of the screen, alternately. For slow speeds, portions of the trace to be displayed during a given screen sweep are cut up: chop mode.

Deflection coefficient

This defines the minimum amplitude (sensitivity) and maximum amplitude values accepted by the input Y.

Trigger

This is a circuit which authorizes the horizontal sweep and determines the signal's starting point. The "trigger level" is the voltage level which must be reached by the signal observed in order to sweep. Alternate triggering provides stable display of the traces in all cases.

XY function

This is a function which allows display of one channel (Y1) as a function of another channel (Y2) on screen; the time base is then inoperative.

Introduction

This is an instrument which allows users to view, as a function of time, the waveform of a periodic electrical signal or a single event. Because it is based on digital processing, it allows storage of the signals and automatic measurements and transfer of the data onto a PC.

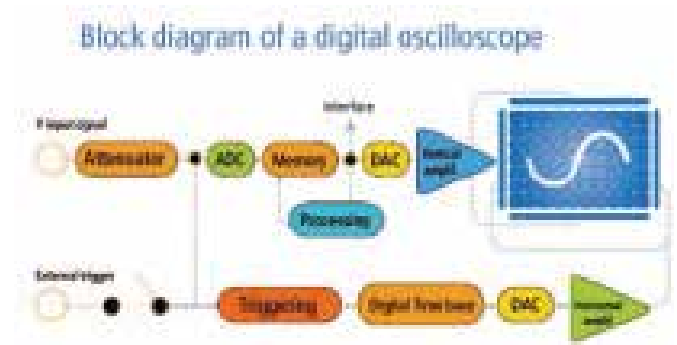

Choosing your digital oscilloscope

Sampling frequency (or rate)

This is the reciprocal of the sampling interval and it is expressed in MegaSamples per second (MS/s). It varies according to the sweep speed. According to Shannon's theorem, for a pure sinusoidal signal, this frequency must be at least twice the frequency of the signal to be observed. In practice, the oscilloscope must sample at a frequency at least 10 times the presumed frequency of the signal. The "useful bandwidth" will be one tenth of the maximum sampling frequency and will be expressed in MegaHertz.

Sampling modes

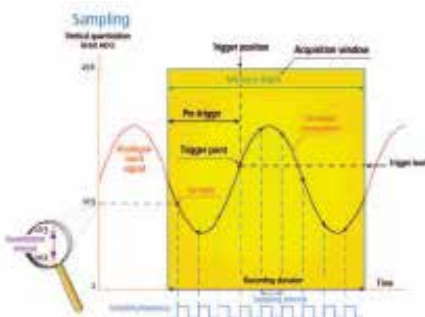

For "real-time" or "one-shot" sampling, all the samples are acquired in a single sweep. "Equivalent time" sampling can be used to achieve higher "sampling frequencies" because the samples are acquired in several successive sweeps. This mode is reserved for periodic signals.

Deflection coefficient

This defines the minimum amplitude (sensitivity) and maximum amplitude values accepted by the input Y.

Memory depth

This is expressed in kilo points (kpoints). It determines the "recording duration" according to the sweep speed; the larger it is, the longer the recording duration. Conversely, an instrument with ten times more memory capacity can sample 10 times quicker for the same recording duration.

Vertical resolution

"Quantification" involves converting the value of a sample into a binary number. The vertical resolution is defined by the capacity in bits of the Analogue/Digital Converter (ADC). It is 1/256 or 0.4 % for an 8-bit ADC ($2^8 = 256$).

Signal processing

This involves very useful mathematical operations between signals:

+, -, *, and even complex functions (Fourier transform or FFT, harmonic analysis, etc.).

The different types of "measurement" inputs on oscilloscopes

Traditional metal BNC inputs

Class 1 unisolated oscilloscopes

The inputs of traditional unisolated oscilloscopes are equipped with BNC connectors. They comprise a "hot point" connected to the central conductor of the BNC and a "cold point" connected to the metal enclosure of the BNC.

4 mm banana safety inputs

Class 2 double-insulated oscilloscope with channels not isolated from one another

The inputs of double-insulated oscilloscopes are equipped with two 4 mm banana plugs, one for the hot point and the other for the cold point or reference. The cold point or reference is isolated from the earth, so it is floating. When an oscilloscope has several channels (OX 71), the cold points or references of the channels are linked together and isolated from the protective earth. In these oscilloscopes, it is possible to have a cold-point / reference potential different from the potential of the protective earth.

4 mm banana safety inputs

Class 1 differential oscilloscopes

The inputs of differential oscilloscopes have two 4 mm banana plugs per channel: one for the + hot point and the other for the - hot point. The 2 hot points (+ and -) are equivalent because they have the same impedance in relation to the earth. If the oscilloscope has several channels, all the + and - hot points have the same impedance in relation to the earth.

BNC safety inputs with metal enclosures insulated during use

Class 2 double-insulated oscilloscopes with channels isolated from one another

The inputs of double-insulated oscilloscopes with channels isolated from one another are equipped with BNC connectors with metal enclosures insulated when the measurement lead is connected. The cold point or reference is isolated from the earth and the cold points or references of the other channels.

The inputs on our portable oscilloscopes

Thanks to the **independently isolated channels** and the **floating inputs**, the SCOPIX and HANDSCOPE models can perform genuinely differential measurements. One input can measure the voltage between the two signal wires, while the other measures the difference in potential in common mode in relation to the earth, simultaneously and independently. Oscilloscopes with isolated channels are recommended when you are seeking to measure various electrical signals of different types.



Selection guide



Families	In@box Remote screen			Lab Training	Lab
	MTX1052 MTX1054	MTX162	MTX112	Analogue	
				OX71	OX803B OX530
Bandwidth	200 MHz	60 MHz	10 MHz	5 MHz	30 and 40 MHz
Channels (number/type)	2 or 4 /class 1	2 /class 1	2 /Differential	1 + X / isolated	2 / class 1
IEC61010 safety	CATII 300V	CATII 300V	CATII 600V	CATII 400V	CATII 300V
Analogue display or equivalent					
One-shot digital sampling	200 MS/s	50 MS/s	50 MS/s	-	-
ETS repetitive mode	100 GS/s	20 GS/s	20 GS/s	-	-
Vertical resolution	9 bits	8 bits	8 bits	-	-
Detection of transients (Glitch)					
Scaling / Physical unit					
PC communication via Ethernet	•/•	•/•	•/-	-	•/-
10Mb Ethernet + Web server	•			-	-
Mains power supply / Battery					
Integrated mode	OX-REC	OX	OX		
"Oscilloscope" specifications					
Max. input sensitivity	2.5 mV/div	5 V/div	20 mV/div	50 mV/div	1 to 5 mV/div
Max. input amplitude	100 V/div	100 V/div	100 V/div	5 V/div	5 to 20 V/div
Analogue filter	15 MHz, 1.5 MHz, 5 kHz	15 MHz, 1.5 MHz, 5 kHz		-	20 MHz ⁽¹⁾
Time base (per division)	1 ns-200 s	5 ns-100 s	100 ns-200 s	500 ns-0.5 s	"5 or 10 ns 0.1 or 0.2 s"
Roll mode/ XY mode	•/•	•/•	•/•	-/•	-/•
Memory depth	50 k / channel	50 k / channel	50 k / channel	-	-
Acquisition memory	PC hard disk	PC hard disk	PC hard disk	-	-
No. of reference or math curves on screen	4	2	2	-	-
Envelope/Averaging modes	-	-	-	-	-
SPO (Smart Persistence Oscilloscope)	•	•	•	-	-
Automatic measurements/Cursors	20/•	20/•	19/•	-	-/•
Pulse trigger on width/number	•/•	-	-	-	-
Video trigger (line counter)	•	-	-	-	•
Trigger on measurement & Automatic backup	-	-	-	-	-
Adjustable Hold-Off / Delay	-	-	-	-	-
Calculation functions + - / x / : / Advanced	•/•	•/•	•/•		•/-/-/-
Autoset with selection of channels	•	•	•	-	•
Other functions					
Spectral analysis, FFT Lin & Log	9 bits / 54 dB	8 bits / 48 dB	8 bits / 48 dB	-	-
TRMS multimeters	-	-	-	-	-
Harmonic analysis	31 orders	-	-	-	-
Threshold recorders (no. of channels)	2 or 4	-	-	-	-
Power / Power harmonics measurement	-	-	-	-	-
General specifications					
LCD colour screen / B&W / Tube	PC screen	PC screen	PC screen	-/-/•	-/-/•
100% "closed casing" soft calibration"	•	•	•	-	-
ScopeNet PC web server/ANDROID app	•/•	-	-	-	-
Pages	54-55	52	53	56	56

SCOPEin@BOX screenless oscilloscopes

PC ergonomics and environment

The MTX 1052-PC, MTX 1054-PC & MTX 162 are genuine "scopes in a box". Compact, lightweight and stackable, these measuring instruments can be connected directly to a PC via a USB or Ethernet interface with dedicated PC software. The Wifi versions now allow wireless Ethernet communication.



SCOPEin@BOX control panel. General commands

Users benefit from all the PC's advantages in terms of storage capacity (PC storage capacity) and display (minimum resolution 1024x768), allowing more precise analysis of the curves. The functions are directly accessible from the menus and the Windows toolbar by means of keyboard shortcuts or the mouse. Users control the oscilloscope using the "instrument" control panel, which contains all the commands found on normal oscilloscopes. Online help is also available.

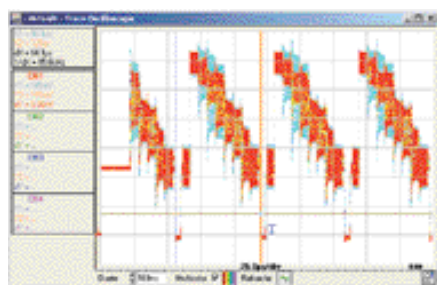

SCOPEin@BOX Display of "X(t)" traces in SPO mode

M u l t i - windowing enables simultaneous display of the traces, the zoom, the FFT analysis and the measurements...

In this way, users can obtain multiple combinations and check out all the relevant information at a glance.

The MTX 1052 & MTX 1054 offer the SPO (Smart Persistence Oscilloscope) display mode. This principle combines the advantages of analogue and digital oscilloscopes. It can be used to manage the display and acquisitions simultaneously, making it possible to increase the acquisition rate to several tens of thousands per second. With SPO, users can detect brief events, instabilities and untimely anomalies.

The MTX 162, an oscilloscope with a "double time base", allows both normal display and remanent display (like on an analogue oscilloscope).

Universal communication

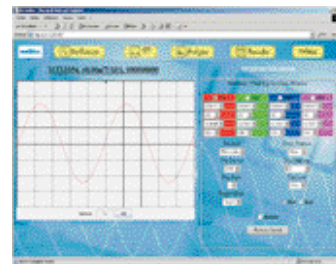

The "W" versions of the SCOPEin@BOX models offer built-in Wifi communication.

Each oscilloscope benefits from a universal USB communication mode and a 10 Mb Ethernet interface for integration in a local or remote network. When started up in USB or ETHERNET mode, the software automatically detects the instruments connected to the PC or to the network. "Unlimited" storage of the traces is possible simply by saving the files. Firmware upgrades are automatic. It is also possible to export results into Excel or print in Word with just 1 or 2 clicks.



MTX105X: ScopeNet for Android tablets and smartphones can be downloaded free from Google Play

Oscilloscopes connected to a PC **DIDASCOPIES**

Compact, economical and simple to use, the **MTX112** and **MTX162** screenless measuring instruments in the in@BOX range benefit **from the same high performance and know-how as all Metrix®** oscilloscopes. When connected to a PC, they take full advantage of all its useful features (large screen, unlimited storage capacity, etc.).



MTX112 10 MHz differential training oscilloscope (Didascope)

PC ergonomics and environment

The DIDASCOPEin@BOX simplified PC software automatically detects the oscilloscope connected to the PC's USB port and starts it up. The software automatically opens a control panel and a trace window. The "READY" LED on the front panel switches off when the PC has taken control of the instrument.

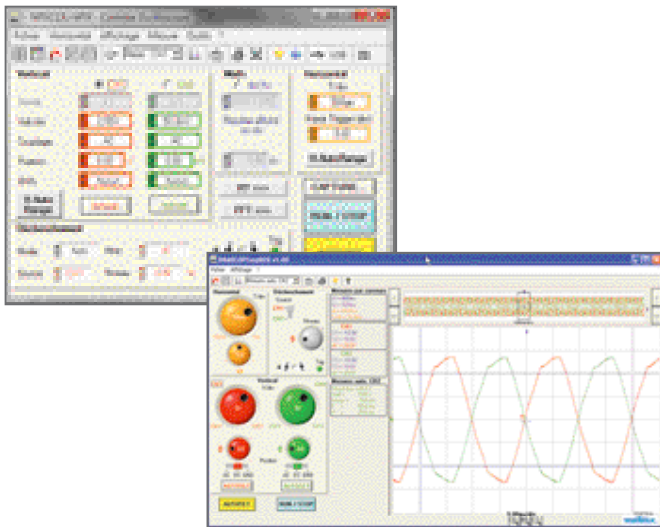

Simple to use

Autoset and Vertical/Horizontal Autorange modes. General Autoset: Vertical - Horizontal - Trigger. Differential capture of the signals with banana leads with the MTX112, just like with a multimeter.

Keyboard shortcuts

The most frequently-used oscilloscope functions are assigned to keys on the PC keyboard. Remanent display. Double time base in real time.

Multi-window display for simultaneously observing:

- The $f(t)$ signal, its FFT and the table of automatic measurements.
- The $f(t)$ signal of channels CH1 and CH2 with its XY representation, etc.
- The signal captured at a given moment and its evolution in real time

Secure firmware releases

The firmware upgrades are performed with the instrument in operation. This takes 3 minutes and the instrument automatically restarts with the new software version if the transfer has been completed correctly. If not, the instrument restarts with the old software version.

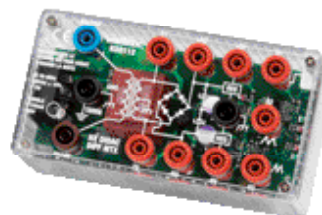

HX0112 - Training kit

Oscilloscope connected to a PC

MTX162

Compact, economical and simple to use, this screenless measuring instrument in@BOX benefits from the same high performance and know-how as all Metrix® oscilloscopes. When connected to a PC, it takes advantage of all its useful features (large screen, unlimited storage capacity, etc.).

- Multiple functions: Oscilloscope, FFT Analyser and Recorder
- Normal or remanent display (like on an analogue oscilloscope)
- Deactivatable vertical and horizontal autorange functions to simplify operation
- Communication: USB, Ethernet and Wifi (MTX 162UEW)
- Automatic detection of the available instruments connected to the PC via USB or the Ethernet network



Specifications		MTX162
Quick selection		
Bandwidth	60 MHz (bandwidth limiter: 15 MHz, 1.5 MHz or 5 kHz)	
Number of channels	2 channels, Class 1, common chassis-earths	
Sampling rate per channel	Repetitive = 20 GS/s - One-shot = 50 MS/s	
Digital oscilloscope		
Vertical sensitivity	8 bits	
Sweep speed	32 calibres from 5 ns to 100 s/div	
Memory capacity	Depth = 50,000 points	
Automatic measurements	19 measurements + Automatic phase On any type of curve - Markers and limits	
Triggering		
Mode	Auto, Triggered, One-shot ROLL, auto level at 50%	
Sources	CH1, CH2, mains	
Type	Rising or falling edge, pretriggering adjustable from 0 to 100 %	
Digital recorder		
Recording duration	2 s to 33 minutes	
Acquisition mode	Dedicated ROLL mode	
General specifications		
Screen commands	"Windows-like" with online help - all commands accessible with mouse	
Communication	USB type B and Ethernet RJ45 (10 Mb local or remote communication), Wifi (MTX 162UEW)	
Dimensions / Weight	270 x 213 x 63 mm / 1.8 kg	
Warranty	3 years / France	

Standard state at delivery

1 MTX 162 oscilloscope delivered with 2 x 100 MHz probes (HX0210), 1 standard USB A/B cable, 1 removable mains power cable and a CD-Rom containing the PC software, the user manual in 5 languages, the programming guide and the drivers

References to order

MTX162UE: MTX162 USB+Ethernet
MTX162UEW: MTX162+WIFI

Available accessories

See pages 107 to 115



For further details...

DIDASCOPEin@BOX

MTX112

The MTX112U is the first screenless digital oscilloscope with 600 V CAT II differential inputs and also the easiest to use. This 10 MHz differential training oscilloscope is also an FFT analyser.



- Simplification of the connections with signal capture using banana leads, like on a multimeter
- A Windows environment with quick display refresh in real time
- Multi-windowed display to observe all the signals simultaneously
- DIDASCOPEin@BOX simplified training software in addition to the complete SCOPEin@box LE software in a single software installation

Specifications	MTX112
Quick selection	
Bandwidth	10 MHz
Number of channels	2 channels, Class 1, differential channels
Maximum sampling rate	Repetitive = 20 GS/s - One-shot = 50 MS/s (on each channel)
Vertical resolution	8 bits
Display mode	8 x 10 divisions - Multi-window (control panel, complete trace, zoomed trace, FFT, XY, measurements, etc.)
Oscilloscope mode	
Vertical sensitivity	12 calibres from 20 mV to 100 V/div
Sweep speed	29 calibres from 100 ns/div to 200 s/div
Memory depth	Acquisition depth = 50,000 points - "unlimited" storage capacity (PC storage capacity)
Number of curves on screen	2 curves + 2 references
Automatic measurements	19 time or level measurements and Phase measurement with SCOPEin@BOX LE and 5 time measurements with DIDASCOPEin@BOX Markers and Limits on all types of curves
Other functions	AUTOSET, +, -, x, /, cursors: dv, dt, 1/dt, phase - cursors linked to the trace or free
FFT mode	
Analysis range	2.5 kpoints on 2 channels
Trigger	
Modes	Automatic, Triggered, One-shot and ROLL
Sources	CH1, CH2, mains (LINE)
Type	Rise and falling edge
Coupling	AC, DC
Sensitivity	0.5 div, adjustment of trigger level ± 8 div.
Digital data storage	
File management	Trace or text (compatible with Windows) for the signals and configuration in SCOPEin@BOX LE and text only with DIDASCOPEin@BOX Screenshot file (depending on Windows print manager configuration)
GLITCH mode (transient capture)	Detection and display of the Min & Max amplitudes between 2 samples - Event duration ≥ 20 ns
Display modes	Vector, Envelope, Averaging (factor 2,4 or 8) and Remanence
XY mode	CH2 versus CH1
General specifications	
PC screen commands	100 % of commands by mouse, "Windows-like menus" & online help - keyboard shortcuts
Configuration memories	"Unlimited", depends on PC configuration
PC interfaces	USB B connector - "Ready" LED on front panel - indication of front-panel test by PC
Safety / EMC	Safety as per IEC 61010-1 (2001) - 600 V CAT II - EMC as per EN 61326-1
Dimensions / Weight	270 x 213 x 63 mm / 1.8 kg
Warranty	3 years

Standard state at delivery

1 MTX112U, 1 mains lead, 2 sets of $\varnothing 4$ mm leads with test probes, 1 USB A/B cable, CD-ROM with SCOPEin@BOX LE and DIDASCOPEin@BOX software, 1 user manual in 5 languages, 1 programming manual in French and English + drivers

Specific accessories

HX0112, DICABOX DIFF MTX Training module including exercises with mains power supply for MTX112U

Reference to order

MTX112U: 1 oscilloscope with 2 x 10 MHz channels and USB

Available accessories

See pages 107 to 115



For further details...



Oscilloscopes connected to a PC

MTX1052 & MTX1054

In addition to the same performance as traditional oscilloscopes, the **SCOPEin@BOX** models also offer the advantage of ergonomics as compact as their price! When connected to a PC, they make full use of all its performance features (large, unlimited storage capacity, etc.), while remaining easy to set up and use.



Versatile

With 4 instruments in 1 for optimum efficiency (oscilloscope, real-time FFT analyser, harmonic analyser and logger), these high-performance oscilloscopes are designed for laboratory applications in electronics, power electronics and electrical engineering.

High-performance

- 2 or 4-channel oscilloscopes, 200 MHz.
- Quick acquisition mode and "SPO" Smart Persistence Oscilloscope display mode.
- Resolution doubled by the 9-bit converter.
- Vertical sensitivity from 250 $\mu\text{V}/\text{div}$ to 100 V/div .
- Acquisition depth of 50,000 points per channel.
- Advanced trigger functions (pulse, delay, counting, main/auxiliary channel, fault capture, etc.).

LX 1600-PC logic analysis probe specially for BUS decoding!

- When the MTX 1052 and MTX 1054 oscilloscopes are used with the 16-channel logic analyser on PC (LX1600-PC), they allow decoding of a large number of buses: UART, I2C, SPI, CAN, LIN, Modbus, etc.
- Oscilloscope acquisition can be synchronized on the basis of the logic analyser trigger conditions.

Ergonomic

- Takes full advantage of the PC screen's size and high resolution
- Multi-windowing with trace, FFT, zoom and automatic measurements simultaneously
- "Windows" environment with familiar ergonomics
- Large storage capacity, direct use of files in Windows (Excel, Word, images, etc.), printing in Windows, etc
- ScopeNet web server on PC, tablet or Android smartphone.

Communication experts

- Equipped with a USB link and Ethernet with integrated web server
- 100%-programmable using the SCPI standard, delivered with LabWindows and LabView drivers
- Products designed for integration in test benches (19" rack versions)



Self-contained bus-decoding probe powered via USB

Specifications	MTX1052	MTX1054
Quick selection		
Bandwidth	150 MHz (Bandwidth limiter: 15 MHz, 1.5 MHz or 5 kHz) or 200 MHz	
Number of channels	2 channels, Class 1, common chassis-earths	4 channels, Class 1, common chassis-earths
Sampling rate per channel	Repetitive = 100 GS/s - One-shot = 200 MS/s (2 channels), 100 MS/s (4 channels)	
Vertical resolution	9 bits	
Display mode	8 x 10 div.- Multiple windows (control panel, trace, zoom, FFT, etc.)	
Probe factors	Scaling of complete physical signal + choice of unit ("windows" virtual keyboard)	
Digital oscilloscope		
Vertical sensitivity	250 μ V to 100 V/div	
Sweep speed	35 calibres from 1 ns to 200 s/div	
Data storage capacity	Memory depth = 50,000 points - storage capacity depends on the configuration of the PC used	
Number of curves on screen	4 curves + 4 references	
Automatic measurements	19 measurements + automatic Phase -On all types of curves - Markers and limits	
Other functions	FFT (calculated over 2,048 points), +, -, x, / - "Made-to-measure" function editor	
SPO (Smart Persistence Oscilloscope)		
Duration of persistence	100 ms, 200 ms, 500 ms, 1 s, 2 s, 5 s, 10 s and Infinite	
Display	Monochrome or colour	
Performance	Acquisition speed 50 kwaveforms/s/channel, No. of samples acquired: 19 MS/s/channel	
Harmonic analyser		
Analysis range	Fundamental + 31 orders, on 1 to 4 channels and fundamental from 40 Hz to 1 kHz simultaneously	
Processing	Permanent display: total RMS value & THD - Selected order: %F, phase, freq, V_{RMS}	
Trigger		
Mode	Auto, Triggered, One-shot	
Source	CH1, CH2, EXT, Mains	CH1, CH2, CH3, CH4, Mains
Type	Edge, pulse width or delay (40 ns-10.5 s), Counting (2-16,384 events), TV (525 = NTSC, 625 = PAL/SECAM), Adjustable pre-triggering from 0 to 100 %, Hold-off (40 ns-10.5 s)	
Coupling	AC, DC, HFR (HF rejection), LFR (LF rejection)	
Sensitivity (CH1, CH2, CH3 or CH4)	0.6 div up to 10 MHz, 1.5 div from 10 MHz to 150 MHz Trigger level +/- 8 div.	
Digital recorder		
Sampling interval	40 μ s to 53.57 s	
Recording duration	2 s to 31 days	
Acquisition mode	Conditioned by thresholds on 4 channels Mode for capture of 100 faults in working memory	
Processing	Time/date-stamped recordings, conversion and units of physical quantities, measurements by cursors and event search, file format compatible with standard spreadsheets (.txt)	
General specifications		
Screen commands	"Windows-like" & online help - 100 % of commands with mouse	
Communication	USB type B and Ethernet RJ45 (10 Mb local or remote communication), HTML server + Wifi, PC or Android tablet	
Dimensions / Weight	270 x 213 x 63 mm / 1.8 kg	
Warranty	3 years	



MTX rack version

Standard state at delivery

1 MTX, 1 mains cable, 2 voltage probes, 1 Ethernet crossover cable, 1 Ethernet straight cable, 1 USB cable, 1 CD-Rom containing the SCOPEin@BOX PC software

References to order

MTX1052B-PC: MTX1052 2 x 150 MHz channels
 MTX1054B-PC: MTX1054 4 x 150 MHz channels
 MTX1052BW-PC: MTX1052B-PC, Wifi version
 MTX1054BW-PC: MTX1054B-PC, Wifi version
 MTX1052CW-PC: MTX 1052C, 2 x 200 MHz channels, Wifi version*
 MTX1054CW-PC: MTX 1054C, 4 x 200 MHz channels, Wifi version*
 MTX1052B-RK: MTX1052B-PC, RACK version
 MTX1054B-RK: MTX1054B-PC, RACK version

Specific accessories

When used with the MTX 1032 double differential probes, they allow effective measurements in total safety on all the sub-assemblies not referenced to earth or possessing differentiated chassis-earths

LX1600-PC: Logic Analysis probe, USB A/B cable, test cables and associated wire-grips, CD-Rom containing the SCOPEin@BOX-Logic Analysis PC software, usable only with a SCOPEin@ BOX

Available accessories

See pages 107 to 115



For further details...

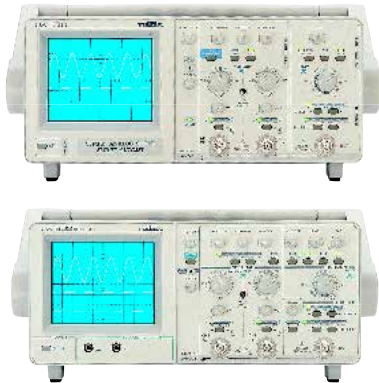

Analogue oscilloscopes with cathode-ray tubes **OX 530 & OX 803B**

Analogue oscilloscopes remain ideal instruments for qualitative analysis and for viewing a signal's waveform as a function of time. These instruments are managed by a microprocessor and offer an AUTOSSET automatic adjustment function as well as alternate triggering.

OX 530

- Simple and economical

OX 803B

- Comprehensive analogue instrument
- Delayed time base and component tester

Specifications	OX 530	OX 803B
Quick selection		
Bandwidth	30/35 MHz	40 MHz
Number of channels	2	
Safety according to IEC 61010	Class 1 - 300 V CAT II	
Input sensitivity	5 mV to 20 V/div	1 mV to 20 V/div
Operating modes	CH1, CH2, ALT, CHOP auto, ADD, -CH2, XY	CH1, CH2, ALT, CHOP, ADD, -CH2, XY, component test
Time base	1	1 + delay
Sweep speed	10 ns to 200 ms/div	
Triggering	CH1, CH2, ALT, EXT, LINE	
AUTOTEST function	SMART AUTOSSET	
Special features	Saving of settings, check on user choices by microprocessor, display of selections by LED	Component tests
Automatic and cursor measurements	-	-
General specifications		
Digital link	RS232 available as an option	
Power supply	94 - 264 V (48/440 Hz)	
Dimensions / Weight	435 x 330 x 163 mm / 5.5 kg	435 x 330 x 163 mm / 6.3 kg
Accessories supplied	1 mains power lead, 1 user manual (S version with 2 probes also available)	

Isolated single-channel cathode-ray training oscilloscope

OX 71

With its coloured buttons and safety banana plugs, the OX 71 is the product of reference for training people how to use an oscilloscope. In terms of safety, their double isolation prevents risks due to connection errors:

- 5 MHz bandwidth
- 50 mV/div to 5 V/div sensitivity in 1-2-5 sequence
- Sweep rate from 500 ns/div to 500 ms/div
- AC, DC and earth coupling
- IEC 61010-1 safety, class 2, 400 V CAT II
- Delivered with training software in 5 languages



Standard state at delivery

1 OX, 1 mains power cable,
1 user manual

Available accessories

See pages 107 to 115

References to order

OX0530: OX 530 oscilloscope
OX0530-S: OX0530 + 2 probes
OX0803B: OX 803B oscilloscope
OX0803BS: OX0803B + 2 probes
OX71: single-channel 5 MHz training oscilloscope

For further details...



Selection guide

OX 6000, DOX 2000 & DOX 3000 family



	Multi-purpose	Expert	Classic	SPO
Selection families	Ox6202B Ox6062B	OXI6204	DOX2025 DOX2040 DOX2100	DOX3104 DOX3304
Bandwidth	60 to 200 MHz	200 MHz	40 to 100 MHz	100 and 300 MHz
Channels (number/type)	2 / class 1 Metal BNC	4 / isolated Plastic BNC	2 / class 1 Metal BNC	4/class 1 Metal BNC
IEC61010 safety	300 V CAT II	600 V CAT II	300 V CAT II	300 V CAT I
One-shot digital sampling	1 GS/s	2.5 GS/s	500 MS/s to 1 GS/s	2 GS/s
Repetitive mode	50 GS/s	100 GS/s	10 to 50 GS/s	
Vertical resolution	10 bits	12 bits	8 bits	8 bits
PC communication via USB / Ethernet	••	••	•/-	••
"Oscilloscope" specifications				
Max. input sensitivity	2.5 mV/div	2.5 mV/div	2 mV/div	2 mV/div
Max. input amplitude	100 V/div	200 V/div	10 V/div	10 V/div
Time base (per division)	1 ns-200 s	1 ns-200 s	2.5 ns-50 s	1 ns - 50 s
Memory depth Acquisition memory	2.5 or 50 k / channel Up to 2 GB on SD Card	50 kpts / channel Up to 2 GB on SD Card	40 kB / channel Up to 2 MB	28 Mpts
Automatic measurements/Cursors	20/•	20/•	32/•	32/•
Other functions				
FFT Lin & Log spectral analysis	10 bits / 60dB	12bits / 60dB	8 bits	8 bits
TRMS multimeters / Generator	200 kHz	200 kHz		25 MHz generator
Harmonic analyser	61 orders	61 orders	-	
Threshold recorders (number of channels)	2	4	Recorder	
Power/power harmonics measurement	•	•	-	
General specifications				
LCD colour screen	5.7 inches	5.7 inches	7 inches	8 inches
Software calibration 100% "casing closed"	•	•		
ScopeNet PC web server/ANDROID app.	••	••		
Pages	58-59	58-59	60-61	62-63



General-purpose digital oscilloscopes

OX 6062B, OX 6202B & OXi 6204

4 modes in one instrument:
oscilloscope + multimeter + recorder + analyser.

- Backlit ¼ VGA colour TFT LCD TOUCH screen
- Multi-interface communication: RS232, USB, Centronics and Ethernet
- High-capacity data storage on removable SD-Card up to 2 GB and more capacity on FTP server
- WEB server for "100 % of functions", FTP server/client for easy file exchange and Instruments Administrator via Ethernet on PC or Android tablet



The OXi 6204 proposes all the functions of a 4-channel SCOPIX with 4 x 600 V CAT II plastic BNC terminals and 1 x RJ45 cable for Ethernet connection.

Extension of storage capacity

As these instruments are equipped with micro SD cards, users can store all the data (reference curves, instrument settings, screenshots) up to 2 GB. The USB/SD card reader delivered with the instrument makes data transfer onto PC quick and simple.

Standard state at delivery

1 OX 6000 oscilloscope , 1 stylus, 1 user manual and 1 programming manual on CD-Rom, 1 µSD card with a minimum capacity of 1 GB plus SD adapter, 2 x 1/10 probes, 1 Ethernet crossover cable and 1 USB / RS232 cable

OX6000B accessories

HX0003: 1/10 safety probe, 150 MHz, 400 V
HX0004: 1/10 safety probe, 250 MHz, 1,000 V
HX0210: 1/1 standard probe, 100 MHz, 300 V CAT II
HX0220: 1/1 standard probe, 200 MHz, 300 V CAT II
HX0077: 50 kpts memory option
HX0028: Harmonic analyser mode
HX0029: Recorder mode

OXi6204 accessories

HX0108: 600 V safety probe + 600 V BAN/BNC adapter
HX0106: BNC-BNC lead 1 m 600 V (x2)
HX0107: BNC-BAN adapters 4 mm 600 V (x2)

References to order

OX6062B-CSD: Digital oscilloscope, 2 x 60 MHz, SD, colour
OX6062B-MSD: Digital oscilloscope, 2 x 60 MHz, SD, B&W
OX6062B-CSDO: Digital oscilloscope, 2 x 60 MHz, SD, colour with all options installed
OX6062B-CFG: Digital oscilloscope, 2 x 60 MHz, SD, colour, with one extra configurable option as selected
OX6202B-CSD: Digital oscilloscope, 2 x 200 MHz, SD, colour
OX6202B-CSDO: Digital oscilloscope, 2 x 200 MHz, SD, colour with all options installed
OX6202B-CFG: Digital oscilloscope, 2 x 200 MHz, SD, with one extra configurable option as selected
OXi6204: Digital oscilloscope, 4 x 200 MHz, SD, colour plus recorder and 50 kpts options installed

Available accessories

See pages 107 to 115

Specifications	OX 6062B	OX 6202B	OXi 6204
Human-Machine Interface			
Display	Colour 1/4 VGA LCD (115 x 86 mm) - 320 x 240 - TFT backlighting (adjustable automatic power off)		
On-screen display of curves	2/4 curves + 4 references		
Commands	32 commands in direct access & shortcuts - 1 on-off and standby button Touch screen - "Windows-like" menus and graphical commands 5 complete languages with menus & online help (English, French, Italian, Spanish and German)		
Vertical			
Bandwidth	60 MHz	200 MHz 15 MHz, 1.5 MHz or 5 kHz bandwidth limiter	
Number of channels	2 Class 1 channels (referenced to earth) 300 V CAT II - Metal BNC	4 isolated channels 600 V CAT II - Plastic BNC	
Vertical sensitivity	Ranges from 2.5 mV to 100 V/div ($\pm 2\%$)		200 V/div
Vertical zoom	"One Click Winzoom" system (graphical zoom directly on screen) - x 16 max.		
Probe factors	1 / 10 / 100 / 1,000 or any scaling - definition of measurement unit		
Horizontal			
Sweep speed	35 calibres from 1 ns/div to 200 s/div.- Roll mode from 100 ms to 200 s/div		
Horizontal zoom	"One Click Winzoom" system (graphical zoom directly on screen) - x 5 max.		
Triggering			
Mode	Automatic, Triggered, One-shot, Auto Level 50 % / CH1, CH2, EXT, LINE Edge, Pulse width (20 ns - 20 s), Delay (120 ns to 20 s), Counting, TV frame or TV line (525 = NTSC or 625 = PAL/SECAM) Continuous adjustment of Trigger position		
Digital memory			
Maximum sampling rate	50 GS/s in ETS mode 1 GS/s in one-shot mode (on each channel) Storage capacity: 2,500 pts per channel (200 curves in memory) or 50 kpts	100 GS/s in ETS mode 2.5 GS/s in one-shot mode	50 kpts
	2 GB on SD card - 2 ns GLITCH mode / Envelope, Averaging (factors 2 to 64) / XY mode		
Other functions			
AUTOSET	Complete in less than 5 s, with recognition of the channels - Frequency > 30 Hz FFT (Lin or Log) with measurement cursors - Functions: +, -, x, / with management of coefficients & units Measurements: 2 or 3 cursors & 20 automatic measurements - Resolution 10/12 bits, 4-digit display		
Multimeter			
Channels / counts	2 channels / 4,000 cts Min/max bargraph - TRMS Time/date-stamped graphical recording (5 min to 31 days)	4 channels / 8,000 cts	
AC, DC, AC + DC voltages	300 to 300 V _{RMS} or 400 V _{DC} V _{DC} accuracy 0.5 %R + 5 D - bandwidth 200 kHz	300 mV to 600 V _{RMS} or 600 V _{DC}	
Resistance	80 Ω to 32 M Ω - accuracy 0.5 %R + 5 D - quick continuity test < 10 ms		
Other measurements	Capacitance: 5 nF to 5 mF / Frequency: 200 kHz / 3.3 V diode test		
Harmonic analyser mode (option)			
	2/4 multi-channel analysis, 61 orders, fundamental frequency from 40 to 450 Hz in auto or manual mode Simultaneous measurements: total V _{RMS} , THD and selected order (% fundamental, phase, frequency, V _{RMS})		
Recorder mode (option)		Integrated	
	Duration / Sampling from 2 s to 1 month / 800 μ s to 18 min. (40 μ s to 53 s with "Extended Memory" option, recording conditions on thresholds or window, simultaneous conditions on several channels, with adjustable duration from 160 μ s, analysis of recordings, scale and physical units, automatic or cursor measurements, time/date-stamped fault search function, zoom, etc.		
General specifications			
Network screen printing (standard), RS232 (standard) or Centronics (optional accessory)	11 B&W or colour drivers: IBM Proprinter, Epson ESC/P, Canon HP PCL, Seiko DPU411, Postscript Image files: ".bmp" approx. 10 kB, ".gif" approx. 5 kB (storage in memory, RS232 or Ethernet transfer)		
PC communication	Local Ethernet, RS 232 (max. 115 kbs) or USB (option) Remote Ethernet 10 Mb and ScopeNet web server "SX-Metro" PC application software (option)		
Mains power supply	Adjustable standby mode Multi-voltage: 98-264 V / 47-63 Hz / < 15 W - Removable cable		
Mechanical specifications	230 (h) x 185 (l) x 180 (w) mm / 2.1 kg		
Warranty	Lifetime warranty		

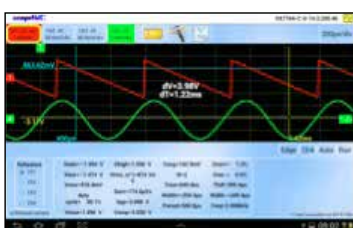

Communication with ANDROID tablets or smartphones



For further details...

2-channel colour digital oscilloscopes

DOX 2000 family



Exceptional ergonomics: extra-bright 7"

- Customization of the display to suit your needs with adjustable colours, graticule, brightness, contrast, etc.
- Simple front panel: traditional front-panel controls (rotary knobs and keys)
- 5 language choices selectable per menu (English, French, Spanish, Italian, German)
- Quick power-up and power-down in less than 10 s
- Easy to transport due to its shape, its built-in handle and its 9-inch depth

format, screen

High performance and multiple acquisition and analysis functions

- Maximum sampling rate of up to 1 GS/s in one-shot mode and 50 GS/s for periodic signals
- Acquisition memory depth from 32 kpoints to 2 Mpoints, depending on the model, to optimize your analyses
- 5 complete trigger types: edge, pulse, video, slope and alternate
- 32 simultaneous automatic measurements on screen and manual cursor measurements
- Recording of up to 6 Mpoints by slow acquisition

Practical interfaces and printing

- Usual communication: USB host and device (PC, Pictbridge printer, USB key)
- Multiple storage: 20 configurations and 5 types of recordings: parameters, curves, images, .csv and factory settings internally or on USB key, etc.
- Comprehensive EASYSCOPE software for all your analyses

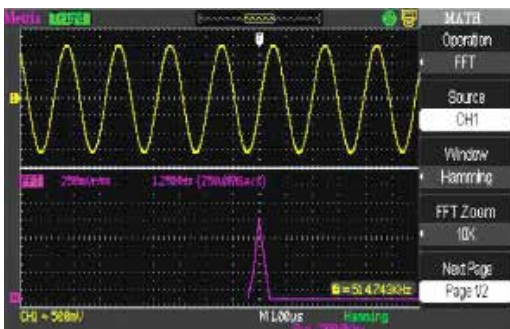

Simple MATH functions +/-/* and "real-time" FFT function with simultaneous display of trace

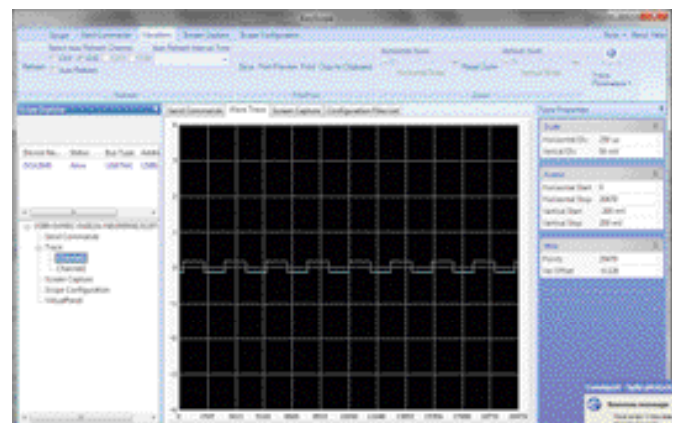

Easyscope software for data processing (csv), SCPI command transmission, screenshots (bmp), configuration, virtual control panel

Specifications		DOX 2025	DOX 2040 / DOX 2100
Human-Machine Interface			
Type of display	7" colour TFT LCD screen (resolution 480 x 234) / Adjustable brightness and contrast		
Display of curves on screen	8 x 18 division trace area / 2 curves + reference + Math function - Complete graticule or borders Display mode: Samples or Vectors with interpolation or Persistence Mode		
Commands	Usual direct commands via buttons on front panel / System with menus on right-hand side of screen with selection using 5 buttons opposite - "Menus On/Off" and print commands		
Choice of language	By menu, 5 languages (FR/EN/DE/IT/ES), online help in English		
Vertical deflection			
Bandwidth	25 MHz	40 MHz / 100 MHz 20 MHz bandwidth limiter	
Number of channels	2 channels, common chassis-earths		
Impedance	1 M Ω / 18 pF and External Trig channel		
Display of traces	Channel number, earth reference indicator and trace in the colour of the channel		
Maximum input voltage	\pm 300 Vp-p (without probe)		
Vertical sensitivity	12 calibres from 2 mV to 10 V/div - Basic accuracy \pm 3 %		
Rise time	< 14 ns	< 8 ns (DOX2040) <3.5 ns (DOX2100)	
Compensated probe factors	1 / 5 / 10 / 50 / 100 / 500 / 1,000		
Horizontal deflection			
Sweep speed	25 ns/div. to 50 s/div. (Oscilloscope mode)	2.5 ns/div. to 50 s/div. (Oscilloscope mode)	
Scan or ROLL mode	100 ms/div. to 50 s/div. (Recorder - Scan mode)		
Horizontal zoom	Yes		
Triggering			
Sources / Modes	CH1, CH2, Ext, Ext/5, mains / Automatic, Triggered, One-shot- XY		
Roll mode	100 ms/div. to 50 s/div.		
Type	Edge, pulse width (20 ns - 10 s), video (Pal, Secam, NTSC), slope, alternate		
Coupling	AC, DC, HFR (HF rejection), LFR (LF rejection)		
Digital data storage			
Maximum sampling rate	One-shot = 250 MS/s (2 channels), 500 MS/s (1 channel) Repetitive = 10 GS/s	One-shot = 500 MS/s (2 channels), 1 GS/s (1 channel) Repetitive = 50 GS/s	
Vertical resolution	8 bits (vertical resolution 0.4%)		
Memory depth	Max. depth = 32 kpoints "Unlimited" storage capacity (USB key)	Max. depth = 2 Mpoints (long MEM) "Unlimited" storage capacity (USB key)	
User memory	2 MB for storing trace, text and configuration files, math functions, print files, image files, etc.		
File management	Trace files (proprietary format and .CSV format compatible with spreadsheets for the signals / Complete instrument setup files / Screenshot files (.BMP format compatible with Windows)		
PEAK DETECT mode (transient capture)	Minimum event duration = 10 ns		
Display modes	Points or vectors Persistence (1s, 2s, 5s, 10s.20s or infinite) or Averaging (factor from 4 to 256)		
XY mode	Yes		
Other functions			
AUTOSET	AUTO-adjustment of amplitude, time base and trigger position		
MATH functions on the channels	Trace calculated in "real time": CH1 and CH2: addition, subtraction, multiplication, division		
FFT analyser	FFT calculated over 1,024 points / Simultaneous display of trace + FFT / 4 window types (Rectangle, Hamming, Hanning, Blackmann)		
Manual measurement cursors	Manual, tracking and automatic modes		
PASS/FAIL	Pass/Fail test on the basis of a limit envelope		
Recorder	Recording mode for slow signals > 100 ms (6 Mpoint ROLL)		
Automatic measurements	32 time or level measurements		
Probe calibration signal	Yes		
Warranty			

Standard state at delivery

1 DOX digital analyser-oscilloscope, European mains power cable, 2 x 1/1 and 1/10 switchable voltage probes, USB A/B cable, CD-ROM containing PC software and user manual

Demonstration board available for practical exercises: HX0074



References to order

DOX2025: Digital oscilloscope 2 x 25 MHz
DOX2040: Digital oscilloscope 2 x 40 MHz
DOX2100: Digital oscilloscope 2 x 100 MHz

Available accessories

See pages 107 to 115



For further details...

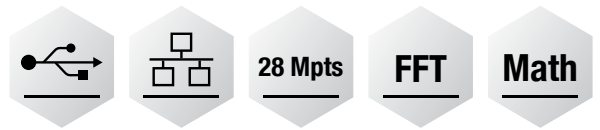

DOX3000 family

Comprehensive with high performance

100 and 300 MHz bandwidth with built-in 25 MHz generator and serial bus decoding

4-channel oscilloscopes with TFT screen 8 inches wide offering 256 levels of colour intensity.

Display using **Sensitive Phosphor Oscilloscope technology for optimized** waveform capture: 110,000 wfs/s, exceptional acquisition and display functions for precisely reconstructing a signal.

Maximum acquisition memory depth: **28 Mpoints**. Practical, intuitive HMI with tradition front-panel commands (rotary knobs with lighting), 5 languages selectable by menu (English, French, Spanish, Italian and German) plus help in French and English.

High-performance oscilloscope with maximum sampling rate of up to 2 GS/s in real time, vertical sensitivity from 2 mV/div. to 10 V/div. and from 1 ns to 50 s/div with complex and complete **triggers** (Pattern, windows, interval, Dropout, runt).

A built-in 25 MHz arbitrary signal generator with programming software is included.

Serial bus decoding function with integrated triggers: I2C, SPI, UART, CAN, LIN and MSO 8-channel digital logic analyser **for analysing digital** transmissions (DOX-MSO3LA option).



Easy analysis with 32 automatic measurements and statistical chart, manual cursor measurements and advanced math functions: simultaneous display of trace + 4-channel FFT.

Communication: USB host, USB key and device (PC, Pictbridge printers) and Ethernet.





Specifications	DOX 3104	DOX 3304
Interface		
Screen	Colour 8" TFT LCD screen, 800 x 480 pixels, 24 bits	
On-screen display	On 8x14 div with 4 channels + reference + Math functions and statistics table - full screen Vector or point modes with interpolation, permanent SPO mode: normal or colour	
Language	French, English, Italian, Spanish and German	
Vertical deflection		
Bandwidth	100 MHz / 300 MHz - Bandwidth limiter: 20 MHz	
No. of channels	4 channels + 1 external channel	
Max. input voltage	300 V (DC+AC Pk)	
Vertical sensitivity	12 calibres from 2 mV to 10 V/div - Accuracy $\pm 3\%$ - 8-bit resolution	
Rise time	< 3.5 ns (DOX 3104) / < 1.2 ns (DOX 3304)	
Probe compensation factors	x 0.1 / 0.2 / 0.5 / 1 / 5 / 10 / 20 / 50 / 100 / 200 / 500 / 1,000 / 2,000 / 5,000 / 10,000	
Horizontal deflection		
Time base speed	1 ns/div to 50s/div (oscilloscope)	
Max. no. of traces captured per second	110,000 traces/s	
Horizontal zoom	Compression, expansion	
Automatic ROLL mode	100 ms/div to 50 s/div (1-2-5 step)	
Trigger system		
Sources/Mode	CH1, CH2 or CH3, CH4 Ext, Ext/5, AC line / Auto, Normal triggered, One-shot	
Type	Edge, Pulse (20 ns to 10 s), Slope (rising, falling), Video (NTSC, PAL, SECAM), Windows, Interval, Dropout, Runt, Pattern	
Trigger on serial bus and Decoding	I2C, SPI, UART/RS232, CAN, LIN	
MSO logic analyser input	Option: 8 channels + clock for TTL/CMOS/LVCOM/CUSTOM signals	
Acquisition		
Real-time sampling rate	ETS: 2 GS/s	
Vertical resolution	8 bits (vertical resolution 0.4%)	
Acquisition depth	Up to 28 M: 14 Mpts per channel, adjustable: 7 k / 14 k / 70 k / 140 k / 700 k / 1.4 M / 7 Mpts	
File manager	Trace files (DAV proprietary format and Excel-compatible ".CSV" format) ".set" configuration files - ".bmp" screenshot files	
Acquisition	Normal, Peak detect, Average, High res.	
Peak detection	Minimum event duration = 10 ns	
"Statistics" mode	Measurement of events	
Other functions		
AUTOSET	AUTO adjustment: amplitude, time base and trigger	
MATH function	Trace calculated in real time: CH1, CH2, CH3, CH4, +, -, x, /, (d/dt), integral ($\int dt$) and square root ($\sqrt{\quad}$)	
FFT analyser	FFT calculated on 1,024 points - simultaneously with the waveform for the 4 channels Adjustable windowing: rectangular, Hamming, Hanning, Blackmann	
Cursors	Manual, Track mode and Auto	
PASS/FAIL	Pass/Fail mode with specific terminal for envelope adjustment	
Automatic measurements	32 measurements and statistics table	
Built-in 25 MHz function generator	25 MHz- 125 MS/s - 14 bits - arbitrary function generation with EasyWave	
General specifications		
Recording	Internal storage or USB flash drive on front panel	
Printing	Via USB Host (PictBridge)	
Communication on PC	Via USB device or Ethernet link for EASYSCOPE (OX) and EASYWAVE (GX) software	
Power supply	Universal 100-240 V / 45-440 Hz / 50 VAmx with removable cable	
Safety / EMC / Locking	Compliant with the IEC 6101-1 standard, 300V CAT I - EMC as per EN61326-1 - Kensington lock	
Temperature	Use: 0°C to +40°C - Storage: -20°C to +60°C	
Mechanical specifications	352 x 111 x 224 mm - 3.6 kg (4 channels) - IP20 3-year warranty	

Standard state at delivery

1 DOX digital oscilloscope, European mains power cable, 4 x 1/10 voltage probes, 1 USB cable, USB key containing software, user manual and practical training exercises

Demonstration board available for practical exercises: HX0074

References to order

DOX3304 (300 MHz, 4 channels) + arbitrary generator+ serial bus decoding
DOX3104 (100 MHz, 4 channels) + arbitrary generator + serial bus decoding
DOX-MSO3LA: MSO 8-channel logic probe

Available accessories

See pages 107 to 115



For further details...

SOFTWARE FOR THE DOX FAMILY OF BENCHTOP OSCILLOSCOPES

EASYSCOPEX is the PC data processing software for the oscilloscopes in the DOX family.

It can be used to extend the oscilloscope's functions via USB (without drivers) or Ethernet (DOX 3000), depending on the models, for:

- Recovery of the .csv trace files
- Transmission of programming commands (SCPI format)
- Remote command test via VIRTUAL PANEL
- Recovery of screenshots in .bmp format



Available at the rear of the instrument:

- Input channel for the Pass/Fail mask test, ideal for quickly identifying problems on a signal
- Input channel for external triggering
- PC/device communication interfaces: USB or Ethernet
- Slot for KENSINGTON lock for greater security

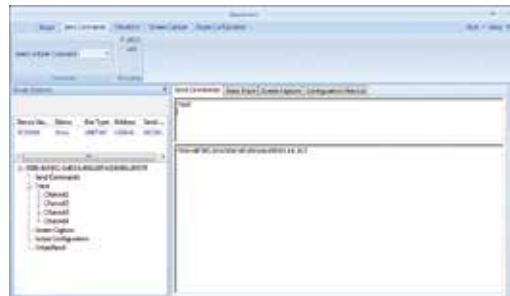

Transmission of SCPI commands

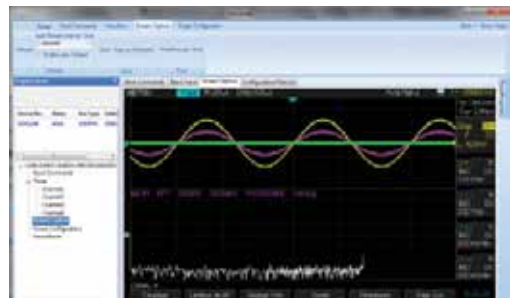

Screenshots

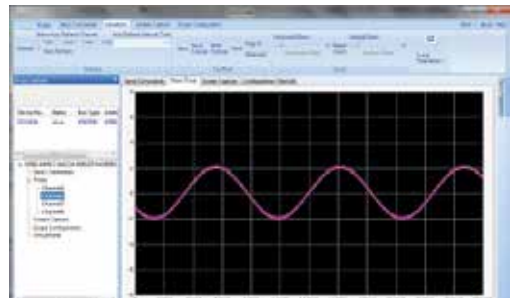

Recovery of traces



Virtual panel

EASYWAVE is PC software which allows users to:

- Recover the curves from the oscilloscope mode and then modify the waveforms using drawing tools
- Transfer or import waveforms into the ARbitrary function (4 memory locations)
- Consult the file library (sine, square, ramp, pulse, noise, cardiac, exponential, etc.) in the memory of the oscilloscope's generator mode

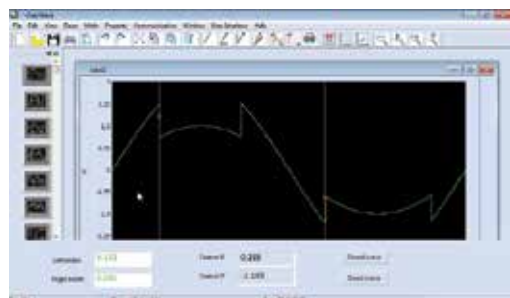

Creation of waveforms

These software products are available from the DOX Support section on our website.

Selection guide



Selection families	"Stand-alone" multi-function oscilloscopes				
	Handscope	Scopix			
	Maintenance	Electronics	Energy	Industrial	Fieldbus
	OX5022 OX5042	OX7202-OX7204 OX7102-OX7104 OX7062	OX7104P OX7042P	OX7042	OX7202 BUS OX7204 BUS
Bandwidth	20 and 40 MHz	60 to 200 MHz	40 to 100 MHz	40 MHz	200 MHz
Channels (number/type)	2 isolated	2 or 4 / isolated	2 or 4 / isolated	2 / isolated	2 or 4 / isolated
IEC61010 safety	1000 V CAT II / 600 V CAT III				
One-shot digital sampling	50 MS/s	2.5 GS/s	2.5 GS/s	2.5 GS/s	2.5 GS/s
Repetitive mode	2 GS/s	50 or 100 GS/s	50 or 100 GS/s	50 or 100 GS/s	50 GS/s
Vertical resolution	9 bits	12 bits	12 bits	12 bits	12 bits
Transient detection (Glitch)	> 20 ns	2 ns	2 ns	2 ns	2 ns
Scaling/physical unit	•/•	•/•	•/•	•/•	•/•
PC communication / Ethernet	•	•/•	•/•	•/•	•/•
Ethernet 10Mb + Web server		•	•	•	•
Mains/battery power supply	•/•	•/•	•/•	•/•	•/•
Alimentation secteur / Batterie	•/•	•/•	•/•	•/•	•/•
"Oscilloscope" specifications					
Max. input sensitivity	5 mV/div	156 µV/div	156 µV/div	156 µV/div	156 µV/div
Max. input amplitude	200 V/div	200 V/div	200 V/div	200 V/div	200 V/div
Analogue filter	1.5 MHz, 5 kHz	15 MHz, 1.5 MHz, 5 kHz	15 MHz, 1.5 MHz, 5 kHz	15 MHz, 1.5 MHz, 5 kHz	15 MHz, 1.5 MHz, 5 kHz
Time base (per division)	25 ns-200 s	1 ns-200 s	1 ns-200 s	1 ns-200 s	1 ns-200 s
Roll mode / XY mode	•/•	•/•	•/•	•/•	•/•
"Memory depth	2.5 k / channel	2.5 to 50 k / channel	2.5 to 50 k / channel	2.5 to 50 k / channel	50 k / channel
Acquisition memory"	2 MB memory	Up to 2 GB on SD card	Up to 2 GB on SD card	Up to 2 GB on SD card	Up to 2 GB on SD card
No. of reference or math curves on screen					
Envelope / Averaging modes					
SPO (Smart Persistence Oscilloscope)					
Automatic measurements / Cursors	-	•/•	•/•	•/•	•/•
Pulse trigger width/number	-	•	•	•	•
Video trigger (line counter)	-	•	•	•	•
Trigger on measurement & automatic backup	-	•/•	•/•	•/•	•/•
Adjustable Hold-Off / Delay	•/•/•	•/•/•/•	•/•/•/•	•/•/•/•	•/•/•/•
Advanced + - / x / : / calculation functions	•	•	•	•	•
Autoset with channel selection	•	•	•	•	•
Other functions					
FFT Lin & Log spectral analysis	-	12 bits / 72 dB	12 bits / 72 dB	12 bits / 72 dB	12 bits / 72 dB
TRMS multimeters	50 kHz	200 kHz	200 kHz	200 kHz	200 kHz
Harmonic analysis	31 orders	61 orders	61 orders	61 orders	
Threshold recorders (no. of channels)	2	2 or 4	2 or 4	2	2 or 4
Power/Power Harmonics measurement	•	•	•	•	
General specifications					
Colour LCD / B&W / Tube screen	•/-/-	•/-/-	•/-/-	•/•/-	•/•/-
100% "casing closed" software calibration	•	•	•	•	•
ScopeNet PC web server / ANDROID app		•/•	•/•	•/•	•except bus /•
Pages	66-67	68-69-71	68 to 70	68-70	72

OSCILLOSCOPES WITH ISOLATED CHANNELS



Stand-alone portable digital oscilloscopes **OX 5022 & OX 5042**

The most compact oscilloscopes with totally isolated channels on the market for all your work on electrical installations in the field as well as for general maintenance.



The 20 and 40 MHz HANDSCOPE models are compact, simple and effective tools for your troubleshooting, with 2 totally-isolated channels to measure all industrial signals.

■ 4 tools in 1 in addition to the Oscilloscope function:

- 2 multimeter (8,000 counts) and recorder channels:
 - + Harmonic analyser: on fundamentals from 40 Hz to 450 Hz
 - + Power measurement
- As well as math functions and simple triggers with automatic scaling.

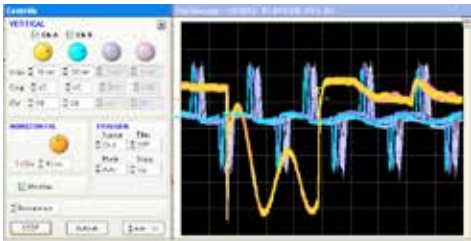

Ergonomics

Icons help you understand the measurements

- 3.5" colour TFT screen with LED backlighting and 320 x 240 resolution
- Simple to use: one key equals one function (triggering, configuration, etc.)
- Integrated interactive multilingual help function
- Recording of the measurements
- Isolated USB communication using the SCPI protocol

Applications

The HANDSCOPEs are ideal for maintenance and troubleshooting in the field, technical education, etc.

There are a large number of possible applications: measurements on 2 signals with different earths, power measurements on variable speed drives with display of the waveform, analysis of the mains outage time (equipment operating on battery), etc.)

It is possible to store the graphs, data points and screenshots to help you produce your reports.

And the HANDSCOPEs are delivered with probes and a banana adapter for measurements up to 600 V. A version specially designed for education (-KE) is delivered with 2 banana-socket inputs to simplify your connections for practical exercises in total safety.

The SX METRO software is an additional post-processing tool for processing your data: min./max., remanence when testing, FFT, math, filter, decoding and power functions, etc.



www.handscope.chauvin-arnoux.com



Specifications	OX 5022	OX 5042
Quick selection		
Bandwidth	20 MHz	40 MHz
Bandwidth limiter	1.5 MHz, 5 kHz	
Number of channels	2 totally-isolated channels	
IEC 61010 safety	600 V CAT III	
Maximum sampling rate	2 GS/s in ETS mode - 50 MS/s in one-shot mode on each channel	
Vertical resolution	9 bits	
Display mode	2,500 real acquisition points on screen Envelope, Averaging (factors 2 to 64) and XY (vector)	
Digital oscilloscope		
Vertical sensitivity	5 mV to 200 V/div	
Sweep speed	25 ns/div to 200 s/div -Roll Mode from 100 ms to 200 s/div	
Data storage	Memory depth: 2,500 points per channel 2 MB for storing files: trace (.trc), text, (.txt), configuration (.cfg) and image files (.bmp)	
Display of curves on screen	2 curves + 2 references + memory trace or mathematical calculation	
Automatic measurements	18 time or level measurements and phase measurement 2 cursors: V, T, dV, dt simultaneously -4-digit display resolution	
Triggering	Automatic, triggered, one-shot & triggered Roll on Edge or Pulse Width (20 ns - 20 s)	
TRMS multimeter		
Specifications	2 channels, 8,000-count display + min/max bargraph	
Recording	Graphic recording of 2,700 measurements (5 min to 1 month)	
Measurement functions	AC, DC and AC+DC voltages, resistance, continuity, capacitance, frequency, rotation speed, 3.3 V diode test, temperature measurement (with K thermocouple or infrared probe)	
Power	Single-phase and balanced three-phase active power values (with or without neutral), simultaneous display of current	
Harmonic analyser		
Multi-channel analysis	2 channels, 31 orders, fundamental frequency from 40 to 450 Hz	
Simultaneous measurements	Total V _{RMS} , THD and selected order (% fundamental, phase, frequency, V _{RMS})	
General specifications		
PC communication	Isolated optical USB interface -"SX-Metro" PC application software supplied	
Power supply	6 x LR6 batteries or 6 AA NiMh batteries - Battery life up to 8 hrs 30 min Universal mains adapter isolated from the channels - Quick charging in 3 hours	
Mechanical specifications	214 x 110 x 57 mm - 1.2 kg with batteries moulded elastomer casing, IP54 protection	
Warranty	3 years	

OSCILLOSCOPES

Standard state at delivery

Version C: 1 oscilloscope delivered with 1 x 1/10 600 V probe, 1 BNC/Banana adapter, 1 set of banana leads, 1 mains adapter, 1 set of 6 x AA NiMh batteries, 1 hands-free bag, 1 CD-Rom containing 1 user manual and 1 programming manual.

Version CK: 1 oscilloscope delivered with 1 x 1/10 600 V probe, 1 BNC/Banana adapter, 1 set of banana leads, 1 isolated optical USB communication cable, 1 mains adapter, 1 set of 6 x AA NiMh batteries, 1 hands-free bag, 1 CD-Rom containing 1 user manual, 1 programming manual, the drivers for the optical USB cables and the SX-Metro PC software.

Accessories and replacement parts

- 20 A AC/DC - 100 mV/A current clampHX0102
- C.A 1871 infrared temperature sensor P01651610Z
- C.A 801 simple thermocouple adapter P01652401Z
- C.A 803 differential thermocouple adapter P01652411Z
- C.A 1711 tachometer P01102082

References to order

- OX5022-C: 1 oscilloscope 2 x 20 MHz
- OX5022-CK: 1 oscilloscope 2 x 20 MHz + USB communication
- OX5042-C: 1 oscilloscope 2 x 420 MHz
- OX5042-CK: 1 oscilloscope 2 x 40 MHz + USB communication

Available accessories

See pages 107 to 115
Software: page 76

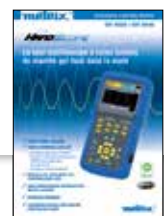

For further details...



The Scopix range

6 modes to cover all the domains from 40 to 200 MHz



Performance

- 5 instruments in 1! All the Scopix models are simultaneously oscilloscopes, multimeters, FFT analysers, harmonic analysers and loggers
- Bandwidth from 40 to 200 MHz
- 2 or 4 isolated channels

Ergonomics

- Monochrome LCD or colour TFT touch screen with LED backlighting
- Traditional control interface: 33 direct command keys
- Control by "Windows-like" menus or graphical objects on the touch screen.

The familiar "Windows-like" environment is simple to learn and use. On the touch screen, users can access all the functions with the stylus via the drop-down menus and can act on the graphical elements (cursors, triggers, etc.).

The PROBIX® "Plug & Play" system for safe, simple use

- Automatic recognition of the sensor type and the associated measurement
- Accessories powered by the instrument
- Automatic scaling and measurement units

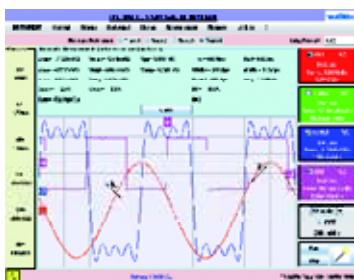

The Ethernet interface and SCOPENET can be used with a PC to control and view all the SCOPIX models by means of their IP address and a simple browser. An ANDROID application for tablets and smartphones can also be downloaded from Google PLAY.

Universal communication

- Multiple interfaces: RS232, USB, Ethernet
- Removable microSD card for large-capacity data storage and transfer
- ScopeNet with cursors and automatic measurements
- FTP server/client and Instrument Administrator on Ethernet

The extensive functions of the SCOPIX family make it ideal for the requirements in several sectors of activity:

- In the industrial maintenance sector, the OX 7042 and OX 7104 are designed for maintenance technicians (see details of functions on page 70)
- In the Energy sector, the OX 7042P and OX 7104P are available in "Power" versions with special accessories and application modules
- In Electronics, the OX 7062, OX 7102, OX 7104, OX 7202 and OX 7204 have all the features necessary to meet the needs of technicians and engineers involved in the design, commissioning or maintenance of equipment (see details of functions on page 71)

SCOPIX III, the multi-function portable oscilloscopes which are also measurement experts

Specifications	OX 7042	OX 7062	OX 7102	OX 7104	OX 7202	OX 7204
Quick selection						
Bandwidth	40 MHz	60 MHz	100 MHz	100 MHz	200 MHz	200 MHz
	15 MHz, 1,5 MHz and 5 kHz bandwidth limiter filters					
Number and type of channels	2 isolated channels			4 isolated channels	2 isolated channels	4 isolated channels
IEC 61010 safety	600 V CAT III					
Sampling rate per channel	2.5 GS/s in one-shot mode, 100 GS/s for periodic signals					
Transient detection	"Glitch" capture, minimum duration 2 ns					
Vertical resolution	12 bits, giving a vertical resolution of 0,025 %					
Display modes	Vector, interpolation, persistence, envelope, averaging (factors 2 to 64)					
Scaling and physical units	Definition of any factor and the corresponding unit					
Digital oscilloscope						
Input sensitivity	2.5 mV to 200 V/div (156 μ V max. with zoom thanks to the 12-bit resolution)					
Time base	1 ns to 200 s/div, Roll mode from 100 ms to 200 s/div					
Data storage	Several tens of thousands of 2,500-point curves (in universal "text" format) Memory depth up to 50 k - Mass storage on removable SD card up to 2 GB					
Reference curves on screen	1 per active channel (1 to 4) / Direct storage with dedicated key					
Automatic measurements with marker	20 simultaneous measurements on curves or deviations from the reference curve - 12-bit resolution					
Triggering	Edge, pulse width, delay, counting, video with line counter and on one of the 20 automatic measurements					
Calculation functions on channels	FFT on 2,048 points, +, -, x, /, and complex function generator					
TRMS multimeter (AC, AC+DC)						
Measurement channels with 200 kHz bandwidth	2 isolated channels			4 isolated channels	2 isolated channels	4 isolated channels
Measurement functions	Voltage, current, frequency, capacitance, temperature (Pt 100, K TC), diode test and audible continuity test, relative mode, min/max mode					
Graph of measurements with cursors	Duration from 5 min to 31 days, data storage in "universal text" format Triggering on threshold checks					
Harmonic analyser*						
Multi-channel analysis (2 or 4 depending on model)	61 orders, fundamental frequency from 40 Hz to 450 Hz					
Simultaneous measurements	Total V_{RMS} , THD and selected order (% fundamental, phase, frequency, V_{RMS})					
12-bit digital recorder*						
Multi-channel recording	Duration from 2 s to 31 days, normal mode or automatic fault capture mode with pre-trigger Sampling interval from 40 μ s (50 k memory)					
Recording conditions	On thresholds or windows, simultaneous conditions on several channels Recording (50,000 points) on the PC hard disk or SD card					
Analysis of recordings	Scale and physical units, measurement by cursors, fault detection, zoom, etc.					
Power measurement*						
Measurement functions	Active, reactive and apparent power, on single-phase or three-phase, and PF					
Harmonics	Harmonic analysis on apparent power					
General specifications						
"Windows-like" operator interface	B&W or colour*	Colour				
Simultaneous display of traces	Up to 4 traces + 4 references on screen / "Full screen" trace mode					
PC communication and printing	RS232*, isolated USB* or Ethernet 10 Mb / Network or Centronics* printers FTP mode to use the PC hard disk as a storage unit Virtual Printer server LPD for printing on a printer connected to a PC Web server with real-time display, remote control and automatic measurements					
Power supply by rechargeable battery	Battery life up to 8 hrs, quick charging in 2 hrs without removing the batteries					

* Depending on models or option



www.chauvin-arnoux.com/scopix



Scopix Industrial Maintenance **OX7042 & OX7104**

2 models equipped with a broad range of functions for acquiring and recording anomalies

- Bandwidth: 40 or 100 MHz
- 2 or 4 isolated channels, 600 V Cat III safety (1,000 V with the HX0030B probe or the HX0095 adapter)
- Colour or monochrome screen

For the Oscilloscope, Recorder and Multimeter modes, it is possible to capture faults by setting a software trigger based on monitoring of the tolerance interval qualified by a duration.

Oscilloscope mode: capture on automatic measurements

20 different automatic measurements

Users have access to 20 automatic measurements in this mode.

Once the required measurements have been selected, all you have to do is set the trigger thresholds and activate fault capture.



Storage and automatic reactivation of acquisitions on threshold overruns (AUTO, NORMAL, SINGLE or ROLL)

Mains monitoring or surveillance mode on up to 4 channels in multi-meter mode

If the RMS value of the signal reaches the min or max levels, defined on each channel, the event is recorded and dated in a list of faults; this list can be saved in a file.

Recorder mode: fault capture

To monitor the variations of physical or mechanical phenomena over time, there is a software module available to integrate a genuine

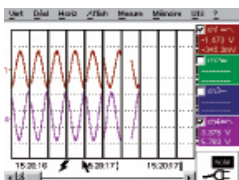

fast digital recorder into the instrument. It offers acquisition intervals as short as 40 μ s between 2 measurements and the recordings may cover any period from 2 seconds to one month.

Automatic fault capture can be performed by monitoring 1 or 2 thresholds per channel. The fault duration can be set from 160 μ s to approximately 8 days. This type of monitoring can also be performed on tolerance windows. Capture triggers storage of the phenomenon observed in non-volatile memory (up to 50 kpoints) or automatic acquisition of successive time/date-stamped faults (max. 500 faults). The faults recorded automatically are stored either in the instrument's internal memory or on an FTP server (PC hard disk).

Harmonic Analyser mode

Harmonic analysis is performed up to the 61st order (THD on a minimum of 50 orders), with a fundamental frequency between 40 and 450 Hz. It is possible to preselect the frequency of the fundamental for the standards (50 Hz, 60 Hz and 400 Hz). This function helps to improve analytical performance and above all allows measurement when the level of a

harmonic order is greater than the level of the fundamental.

It is possible to view the harmonic analyses of two or four channels simultaneously

Multimeter mode: monitoring of measurements

Fault capture is performed by monitoring 1 or 2 thresholds per channel. The fault duration can be set from 48 ms to approximately 8 days. All the faults captured (several thousand can be stored on the SD card) can be recalled by using the Scopix menus. The list of time/date-stamped faults indicates the source and the result of the measurement. This list can be saved in ".txt" format.

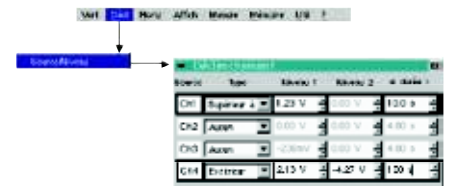

Standard state at delivery

- 1 OX oscilloscope, 1 mains adapter/charger, 1 NiMH 9.6 V - 3.8 A/h battery pack, 1 x 1/10 Probix probe, 1 banana Probix adapter, 1 set of banana leads, 1 Ethernet crossover cable, 1 USB cable, 1 μ SD card with SD-card adapter, 1 magnetic stylus, 1 operating and programming manual

References to order

- OX7042-MSD: Oscilloscope, monochrome screen, 2 x 40 MHz
- OX7042-CSD: Oscilloscope, colour screen, 2 x 40 MHz
- OX7104-CSDK: Oscilloscope, colour screen, 2 x 100 MHz + SX-Metro

Available accessories

See pages 107 to 115

Scopix Electronics

OX 7062, OX 7102, OX 7104, OX 7202 & OX 7204

The 5 models in this range are ideal for the needs of the electronics sector, from PCB design to the development of complex systems.

- 156 μV / div input sensitivity for studying signals with very low amplitudes
- Bandwidth of 60 to 200 MHz
- 2 to 4 isolated channels

A high-performance instrument

- Sampling rate of 2.5 GS/s per channel in one-shot mode and 100 GS/s in repetitive mode.
- 12-bit converter providing a vertical resolution which is 16 times greater than the resolution offered by the conventional 8-bit oscilloscopes on the market.
- Isolated channels for simultaneous measurements without signal constraints and with different chassis-earth references for very low sensitivities and for signals up to 1,000 V_{DC} or rms.
- 2 MB internal memory, up to 2 GB of data on SD Card and direct storage on PC hard disk via Ethernet (FTP Server/Client)

2 or 4 independent 200 kHz TRMS digital multimeters

Just as for the 4 "instrument" modes, a single press on the dedicated key gives access to the multimeter. These 2 or 4-channel TRMS digital multimeters can be used for the following measurements:

- amplitude (DC or AC voltage or current, power, temperature, etc.)
- resistance, continuity and capacitance
- junction or diode tests, etc.

Pt 100 sensors or K thermocouples can be used for temperature measurement.

The associated recorder can be used to monitor and save any changes in the measurements over periods of 5 minutes to 1 month

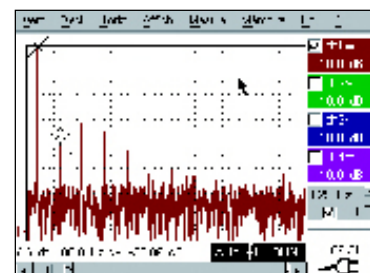
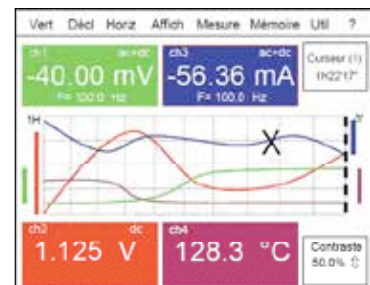
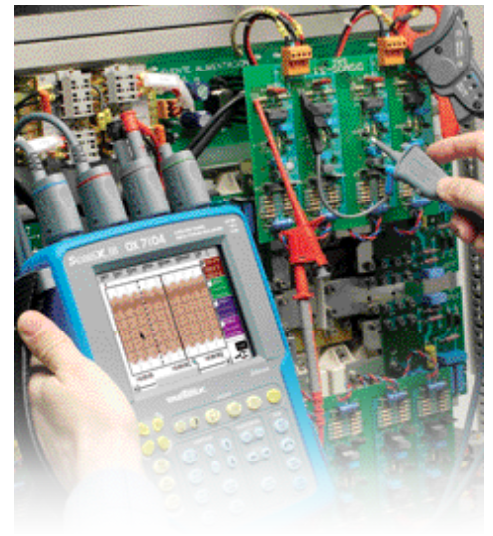

FFT with a Hanning window and a logarithmic scale



Standard state at delivery

1 OX oscilloscope, 1 mains adapter/charger, 1 NiMH 9.6 V-3.8 A/h battery pack, 1 x 1/10 Probix probe, 1 banana Probix adapter, 1 set of banana leads, 1 Ethernet crossover cable, 1 USB cable, 1 μSD -card with SD-card adapter, 1 magnetic stylus, 1 operating and programming manual

Available accessories

See pages 107 to 115

State at delivery for "CSDO models"

Same as "standard" plus 2 x 1/10 Probix probes, Harmonics, Recorder and 50 kb options installed, SX-METRO-P software and a hard case

References to order

- OX7062-CSD: 2 x 60 MHz oscilloscope
- OX7102-CSD: 2 x 100 MHz oscilloscope
- OX7104-CSDK: 4 x 100 MHz oscilloscope + SX-Metro + hard case
- OX7202-CSD: 2 x 200 MHz oscilloscope
- OX7204-CSD: 4 x 200 MHz oscilloscope
- OX7104-CSDO: 4 x 100 MHz oscilloscope + Options
- OX7204-CSDO: 4 x 200 MHz oscilloscope + Options



For further details...

Scopix Fieldbus

OX7202-BUS & OX7204-BUS

Multi-function oscilloscopes:

- oscilloscope, multimeter, recorder & bus analyser;
- 200 MHz on 2 or 4 channels;
- memory depth: 50 kpts.

This specific version for fieldbus integrity testing, SCOPIX BUS offers electrical and physical maintenance of all your fieldbuses: AS-I, DALI, CAN, KNX, ETHERNET, MIL STD1553, ARIN159, USB, FLEXRAY, LIN, PROFIBUS and RS232/485 according to the existing standards:

Simplified test

Tolérance des mesures			
can 2 @ Full speed			
	Min	Max	Avertis.
V _{High}	300mV	1.80 V	85.0 %
V _{Low}	-3.60 V	-240mV	85.0 %
Time Rise	4.80ns	30.0ns	70.0 %
Time Fall	4.80ns	30.0ns	70.0 %
Data Width	---	---	70.0 %
Time Data	---	---	70.0 %
Jitter	---	24.0 %	70.0 %

Link quality test

The diagram of the eye offers a visual diagnosis to check and assess the transmission quality of a digital bus.

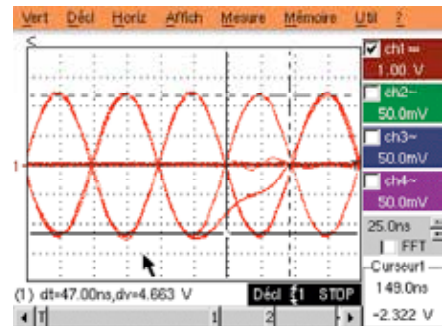

All the Scopix communication tools are provided as standard, with:

- SX-BUS bus creation and modification software for better adaptation to the standards and any changes to them: modification of the standard limits, measurement tolerances in MIN/MAX and % on SCOPIX BUS
- Display of the results from the last analysis: these results can be saved in a ".htm" file in the internal memory (1 MB), on the SDCard (2 GB max.) or on an FTP server.

Visual help for the steps, the overall result in colour and the result of each test in colour, along with pictograms comparing the value to the tolerance of the standard: .

Help at connection with a reminder of the input channels and the assembly diagrams for each bus.

Help with connection to the fieldbuses using cards equipped with SUBD9 or RJ45 or M12 connectors or 8-wire screw connectors: HX0190 and HX0191.

Help with troubleshooting in the User Manual and the booklet of bus descriptions by standards.

References to order

- OX7202-BUS: oscilloscope 2 x 200 MHz
- HX0190: DB9F and RJ45 connection boards
- OX7204-BUS: oscilloscope 4 x 200 MHz
- HX0191: M12 and 8-wire connection boards

Available accessories

See pages 107 to 115

For further details...



Advantages of the Patented Probix System



Scopix portable oscilloscopes benefit from Probix smart accessories which offer users a host of innovative functions guaranteeing simplicity, effectiveness, versatility and safety.

The Probix system, with its smart probes, accessories and adapters, ensures quick, error-free implementation of your instrument.

With this "plug and play" measurement system, the probes and adapters are recognized immediately as soon as they are connected. The instrument does not just identify them, however. It also gives information on their specifications.

Active safety is built-in, notably in the form of safety information and recommendations for users based on their specific configuration.

The coefficients, scales, units and channel configurations are managed automatically

This system also allows users to power the accessories directly from an oscilloscope, without a battery or additional mains adapter.

Some Probix accessories include three control buttons directly accessible on the probe. For example, the first two control buttons on the probes are used for direct modification of the parameter settings for the channel to which they are connected.

The Probix DC current sensors are self-powered by the oscilloscope.



HX0034



HX0094



HX0096



HX0072

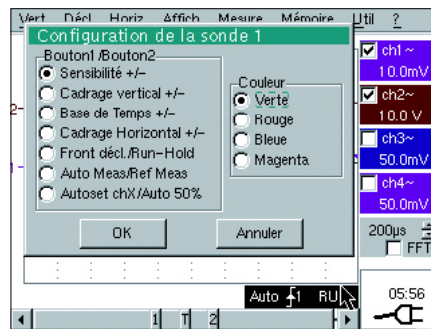

Probix current measurement

- HX0034: 0.02 A to 60 ARMS AC/DC current clamp / 1 MHz
- HX0072: 5 A to 3,000 ARMS AmpFLEX™ AC current sensor / 200 kHz
- HX0073: 1 A to 300 ARMS MiniAmpFLEX AC current sensor / 3 MHz

Probix Adapters

- HX0094: Probix 4-20 mA (process) adapter
- HX0096: Probix BNC adapter/100 mV/A (standard sensors)



For further details...

OSCILLOSCOPES

Advantages of the Patented Probix System

Probix

Probix voltage measurement

Probix voltage probe

HX0030B: 1/10 voltage probe, 1,000 V CAT II, 600 V CAT III, 250 MHz

HX0071: Industrial Accessories Kit for HX0030A probes (wire grip, banana plug, 50 cm earth connection)

HX0130: 1/10 electronic voltage probe, 300 V CAT III, 500 MHz

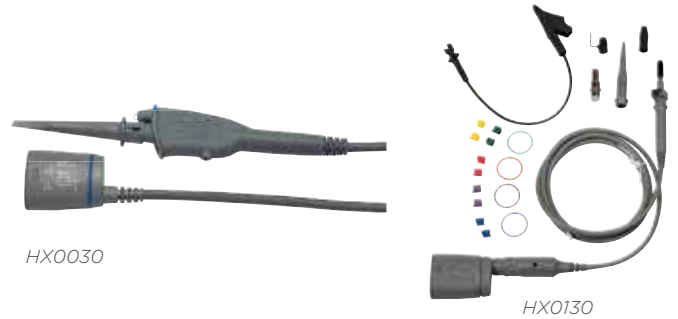

Probix BNC

HX0031: Probix adapter for BNC cables

HX0032: Probix BNC adapter with built-in 50 Ω load



Probix Banane

HX0033: Probix adapter for banana leads, 600 V CAT III

HX0093: Probix adapter with 300 Hz filter (PWM systems), 600 V CAT III

HX0095: Probix adapter for banana leads, 1,000 V CAT II



Temperature measurement

HX0035B: Probix / K Thermocouple adapter



HX0036: Probix / Pt100 Probe adapter



Example of application

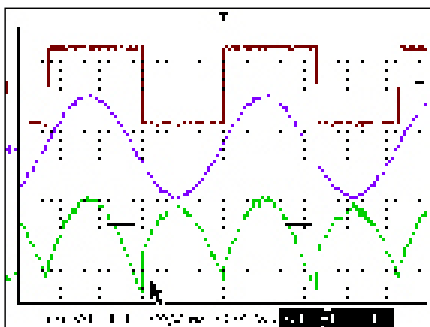

With a Probix AC/DC current probe powered by the oscilloscope and a Probix 1/10 1,000 V voltage probe, thanks to the automatic scaling, unit management and the appropriate Math function (multiplication), you can view the instantaneous power in real time and measure the value.

When 2 channels are multiplied, it is possible to view the scaled result, with its physical unit (e.g. W) and the original curves (in this case, the current and the voltage).



For further details...

The 4 Scopix modes

A multiple instrument for complete, precise diagnosis



A multi-channel 200 kHz TRMS digital multimeter HX0075 power measurement (Option)

Specifications	2 or 4-channel multimeter 8,000 counts - TRMS
AC, DC and AC + DC voltages	600.0 mV to 600.0 V _{RMS} or 800 mV to 800.0 V _{DC} - accuracy V _{DC} 0.5% R + 5 D - bandwidth 200 kHz
General specifications	2 or 4 channels - 8,000 counts max. & Min/Max bargraph - TRMS - Time/date-stamped graphic recording
Resistance	80.00 Ω to 32.00 MΩ- accuracy 0.5% R + 25 D - 10 ms quick continuity test
Other measurements	Capacitance from 5.000 nF to 5.00 mF / Frequency 200.0 kHz / 3.3 V diode test

In multimeter mode, the power measurements are developed as follows:

- Single-phase power
- Three-phase power on balanced network without neutral
- Three-phase power on balanced network with neutral
- 3-wire three-phase power (2-wattmeter method)

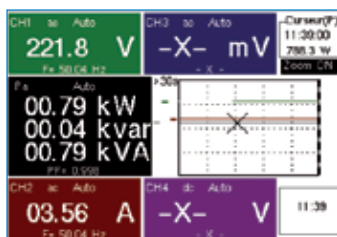

Display of apparent, active and reactive power values and the PF

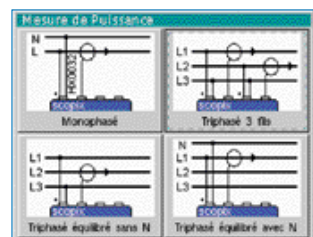

Selection of the type of network supplying the load

Extension of the acquisition memory

HX0077 (Option)

A memory of 50,000 points.



HX0029 recorder (Option)

Specifications	
Acquisition rate	Sampling interval of 800 μs to 17 min 51 s - (standard memory 2,500 points) Sampling interval of 40 μs to 53.5 s - (with 50,000-point memory extension)
Recording duration	2 s to approx. 1 month
Acquisition mode	Conditioned by thresholds or windows "Normal" acquisition or up to 500 faults
Processing	Time/date-stamped graphic recording, conversion and units of physical quantities, measurements using cursors and event searches, file format compatible with standard spreadsheet (".txt")

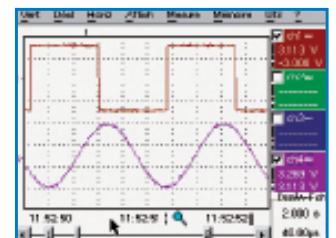
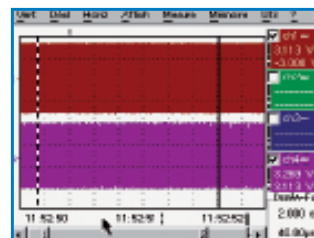

Recorder mode: 50,000-sample acquisition, maximum resolution 40 μs, x100 zoom (one mains cycle)

HX0028 harmonic analysis (Option)

Specifications	
Multi-channel analysis	2 or 4 depending on model 61 orders - frequency of fundamental from 40 to 450 Hz in auto or manual mode
Processing	Permanent display: total RMS value & THD selected order: %F, phase, frequency, V _{RMS}

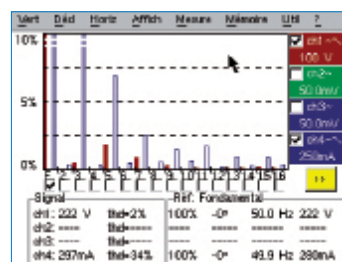

The "vertical zoom" (front-panel button) can be used to adjust the dynamic range as required (0-100 %, 0-50 %, 0-25 %, or 0-10 %).

OSCILLOSCOPES

PC software

SX METRO

USB-RS232 or Ethernet link

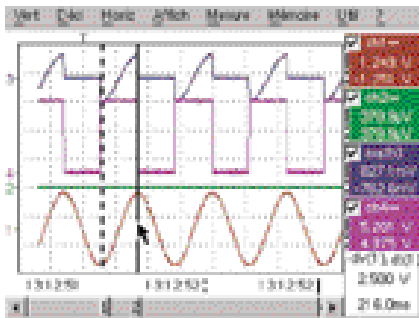
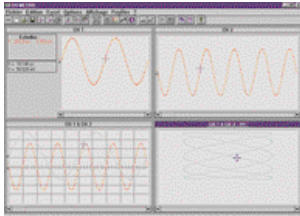

The data processing software for all METRIX® oscilloscopes which allows you to:

- View the curves
- Display the curves on the PC in real time with the oscilloscopes
- Control the oscilloscope remotely via the PC
- Load a configuration into the oscilloscope
- Import curves stored in the oscilloscope's memory, using the following types of "image" files:

File name	Contents
*.trc	a curve which will be displayed in the active graph
*.rec	a recording which will be displayed in a new graph
*.cfg	an instrument configuration
*.bmp	a screenshot
*.grf	a graph with its curves and comments
*.per	a curve in persistence mode

- Store the curves on the PC in text format
- Perform mathematical processing such as the FFT of the signal displayed
- Transfer the data (curves or FFT) into Excel
- Signal demonstration board for METRIX oscilloscopes: HX0074

Reference to order

SXMETRO/P

Virtual printer

For printing ".gif" and ".bmp" files from SCOPIX/OX6000 on a network printer linked to a PC. The software installed on a computer equipped with the drivers for the network printer provides a direct gateway between the oscilloscope and the printer, transforming the PC into an LPD server. This software is a virtual print server which processes the file so that no action is required from the user.

It then sends the prepared file to the network printer. As a result, after configuring the oscilloscope, it is possible to send screenshots directly for printing. This method is simple, quick and effective.

It is delivered on CD with its user manual.

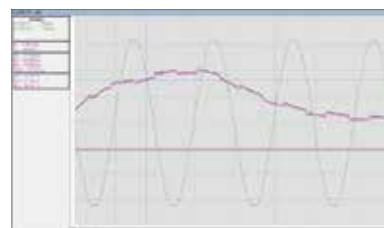
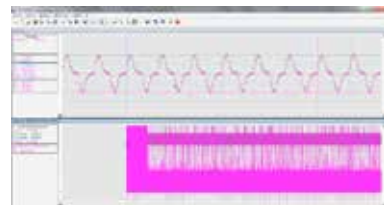
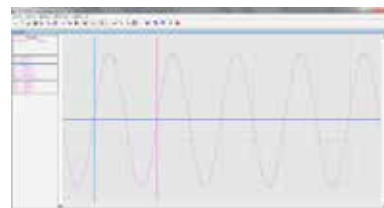

Software not requiring installation

The APPLICATIONS supplied with the SCOPIX-MTX105X and OX6000 models

ScopeAdmin

To control a fleet of instruments directly via a web browser (oscilloscopes equipped with an Ethernet connection).



ScopeNet

Android application
(available from Google Store)



ScopeNet for remote dialogue and parameter settings. This software can be used to view the curves in real time, perform measurements and analyses, capture screens and control METRIX® oscilloscopes from your tablet or smartphone.

With this application, you can monitor the curves and measurements on a METRIX® oscilloscope from the OX7000, OX6000B or MTX105x series via an Ethernet link.

ScopeNet

Application for remote control of an instrument using a PC.

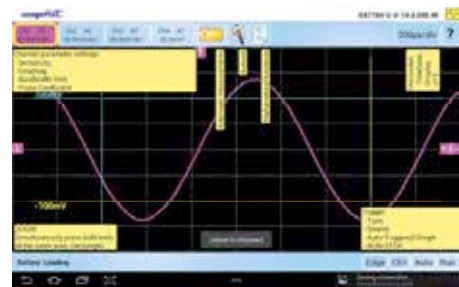
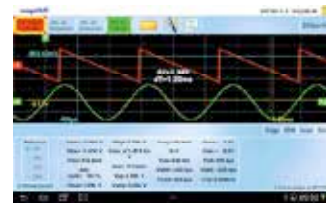
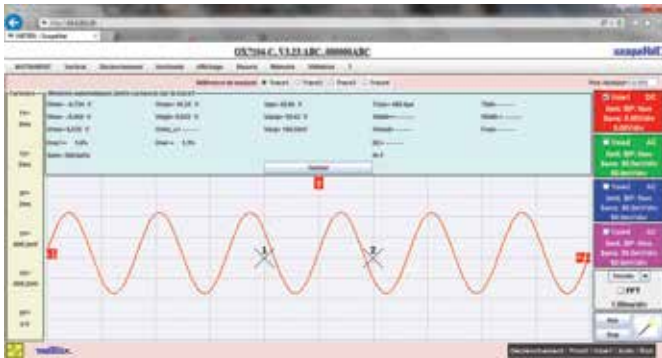

FTP server

Application for remote control of an instrument using a PC.



metrix

Accessories

- USB/microUSB adapter: HX0080
- MicroSD/SD adapter: HX0079

OSCILLOSCOPES

Spectrum analysis

Spectrum analysis can be used to measure the band, detect disturbance lines, quantify phase jitter by direct reading, check the steps, determine the rated frequency, search for residual lines for comparison, etc.

Heterodyne spectrum analyser

Spectrum analysis involves moving a narrow bandwidth filter in front of the signal to be analysed. However, because of the difficulty of producing a narrow bandwidth filter with an adjustable mid-band frequency, the problem is avoided by "heterodyning".

With this technique, the bandwidth filter has a fixed mid-band frequency of F_0 and the signal to

be analysed is modified by modulation, so that the different frequency components are successively modulated to the frequency F_0 . To achieve this, a multiplier is used which outputs the sum and the difference of the frequencies applied to the two inputs, resulting from the trigonometric relation:

$$\cos(a)\cos(b) = (1/2)[\cos(a+b) + \cos(a-b)].$$

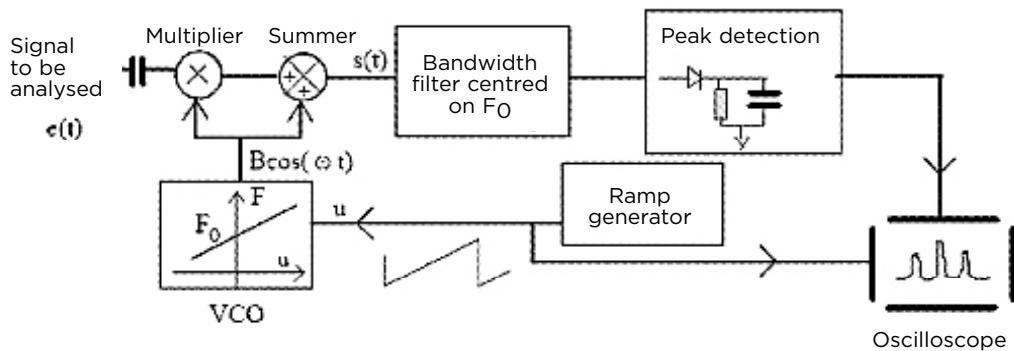

Block diagram of a heterodyne spectrum analyser

The analytical filter

The analytical filter is also called the resolution filter. The narrower the filter, the finer the analysis and the closer you get to the shape of the line analysed (because the filter itself resembles a line). Using different reasoning, it could also be said that a signal passing through an extremely narrow filter can only come out as a pure sine wave, represented by a line!

It is tempting to use a narrower filter to analyse a signal, but compromises need to be made. The narrowness of the filter limits the amount of data that it can supply per second, which means that, to obtain a large number of measurement points (i.e. better frequency resolution), more time will be necessary with a narrow filter than with a wider filter.

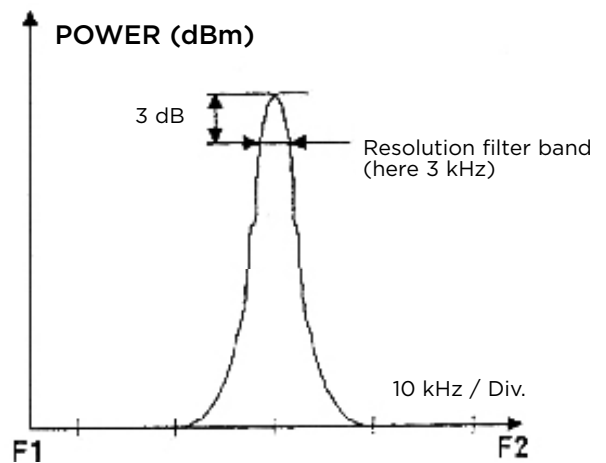

Width of analytical filter

Noise power and power of a line

The analytical filter indicates the power of the FO line when it is centred on it (leaving aside the filter losses which can be compensated). Whatever the width of the filter, the maximum height of the curve on screen will correspond to the power of the line.

Noise measurement depends on the width of the analytical filter

This means that phase jitter can be measured with the spectrum analyser, in dBc/Hz, which is the difference in dB between the FO line power measurements in dBm and the noise power in dBm/Hz at a given distance from the carrier.

Video filter

This serves to smooth the curve on the screen, particularly at the noise level. It has no effect on the actual measurement, as it only applies to the on-screen display of the curve. However, it may affect the sweep time: a 10 Hz video filter will not deliver more than 10 data items per second, so if 1,000 points are necessary to plot the curve, it will not be possible in less than 100 seconds.

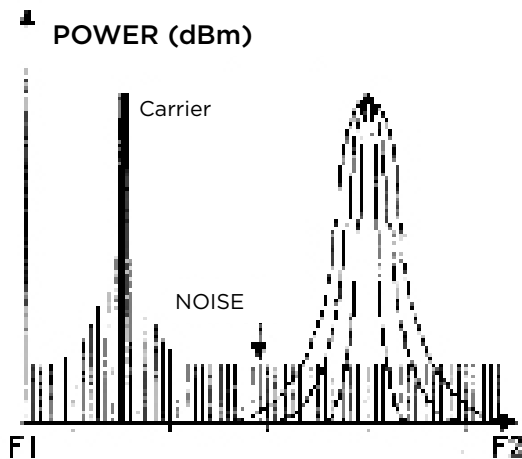

Noise measurement with several analytical filters

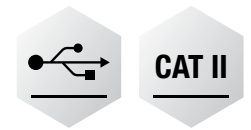

MTX1050

The lightweight, portable MTX1050 general-purpose spectrum analyser is particularly suitable for the needs of small businesses and technical education.

When coupled with the H-field probes, the MTX1050-PC analyser can be used to carry out EMC prequalification tests.

- Particularly compact and economical "screenless" instrument
- User interface via PC: "Plug & Play" USB connection, large high-resolution colour display
- 4 simultaneous measurements (Peak auto, Marker, 2 difference cursors)
- Frequency range from 400 kHz to 1 GHz
- High stability with frequency drift limited to ± 5 ppm/year
- Wide dynamic range for measurement, from -90 dBm to +20 dBm
- 6 sweep speeds, 3 analytical filters and 3 video filters, built-in FM demodulation
- Ideal for EMC testing

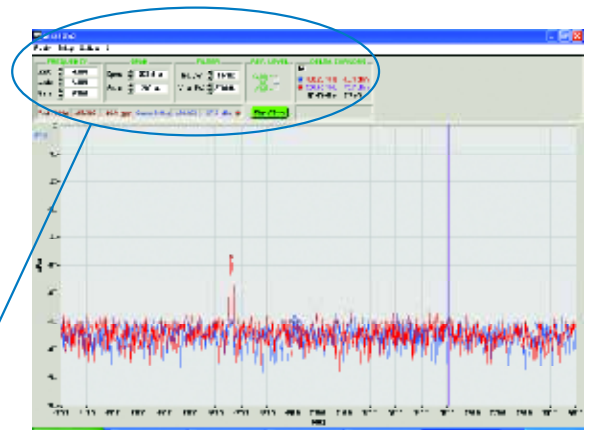

PEAK cursor



Free cursor

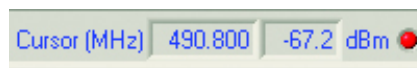

DELTA cursors

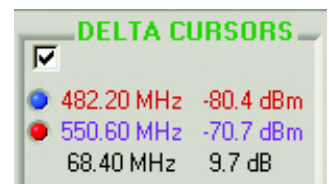

Specifications		MTX 1050
Frequency		
Display	Colour display, high resolution, large dimensions, on PC screen Up to 5,000-point sweep in horizontal resolution (depending on speed)	
Bandwidth	400 kHz to 1 GHz	
Resolution on central frequency value	4 1/2 digits / 10 kHz maxi	
Internal frequency	Accuracy $\pm 0.625 \cdot 10^{-6}$	
Frequency stability	± 5 ppm / 1 year	
Frequency span	Zero Span, 1 MHz to 100 MHz / div - sequence 1-2-5	
Resolution		
Filters	12 kHz, 120 kHz and 1 MHz	
Video filters	1 kHz, 10 kHz and 300 kHz	
Level		
Dynamic range for input	3 ranges from -90 dBm to +20 dBm	
Noise floor level (dynamic range for measurement)	Without amplifier: -80 dBm With amplifier: -95 dBm	
Dynamic range for display	50 dB and 100 dB	
Harmonic response	< -40 dBc for a level of -20 dBm	
Non-harmonic response	< -70 dBc (< -600 dBc on identified frequencies)	
Input		
Max. admissible power	+25 dBm permanent, ± 30 V _{DC}	
Impedance	50 Ω rated	
Input attenuation	One 20 dB-rated attenuator, one 20 dB-rated amplifier	
Connector	BNC	
Markers / Modes	4 simultaneous cursors / 1 automatic "Peak" detection marker, 1 cursor "locked" to the trace and 2 delta cursors	
Functions		
Data storage	On PC, unlimited number, with explicit names Storage and comparison of reference spans 100 to 5,000 samples per sweep (depending on sweep speed)	
Traces	Averaging (factors 2 to 64 / noise suppression and improvement of dynamics) Comparison to a reference and measurement of deviations (frequency & amplitude) Calculation of difference (Spectrum - Reference) and associated measurements Screenshot with all settings - Transfer to Excel	
PC communication	"Plug and Play" USB as standard	
Mains power supply	230 V _{AC} , ± 10 %, 50/60 Hz, approx. 4 W	
Safety / standards	IEC 61010-1 - CAT II / NF EN 61326-1: 98	
Dimensions / Weight	270 (L) x 63 (H) x 215 (W) mm / 1.7 kg	

Specific accessories

HX0082: H-field probes kit, 3 GHz
HX0083: 20 dB amplifier for HX0082 probes

**Standard state at delivery**

1 MTX, 1 mains power cable, 1 CD-Rom containing the PC application software, 1 FM antenna with BNC connection, 1 user manual

Reference to order

MTX1050-PC: 1 MTX 1050PC spectrum analyser

Available accessories

See pages 102 to 103



For further details...

Spectrum analyser and near-field probes

MTX1050, HX 0082 & HX 0083

A set of instruments specially designed for EMC prequalification tests

These tests may take place throughout the design and development of a product.

Prequalification tests help to save time and make sure that the finished product will comply with the applicable standards.

These tests take into account all aspects which help to limit disturbances:

- Choice of components and floorplan on printed circuit boards
- Reduction of cable lengths and use of screened cables when possible
- Separation of circuits/cables of different types (e.g. analogue or digital)
- Checking of electrical continuity (e.g. connections, welds, etc.)
- Verification of the floorplan and screening, etc.

This is not an exhaustive list. Any measurements that may reduce electromagnetic fields should be envisaged to ensure that the product operates correctly.

The tests are divided into 2 main categories: immunity tests and emission tests. They are also performed in 2 distinct modes: "conducted mode", covering disturbances in the cables or printed-circuit traces, and "radiated mode" for the electromagnetic field in the air.

HX0082 near-field probes & HX0083 amplifier

The HX0082 kit comprises 2 near-field probes (30 MHz - 3 GHz). The proximity probe can be used to measure radio-frequency magnetic fields. It can be positioned up to 10 cm from the target. The contact probe is designed for precise measurements on chip floorplans or traces.

Specifications	HX 0083
Power supply voltage	7.5 to 18 V
Current consumption	50 mA
Max. input voltage	25 Vdc
Gain	20 dB
Noise	4.5 dB



Measurements with the HX0082 contact probe



Measurements with the HX0083 proximity probe up to 10 cm from the target

Generator basics

Function generators are among the most widely-used test and measurement instruments. They can generate varied characteristic waveforms in order to test the operation of electronic systems, from very low frequencies of just a few mHz up to 20 MHz or more.

It allows users to adjust the amplitude of these signals up to 20 V or more, possibly with the presence of a DC component.

In addition, they may also provide modulations or specific functions.

Direct Digital Synthesis (DDS) function generator

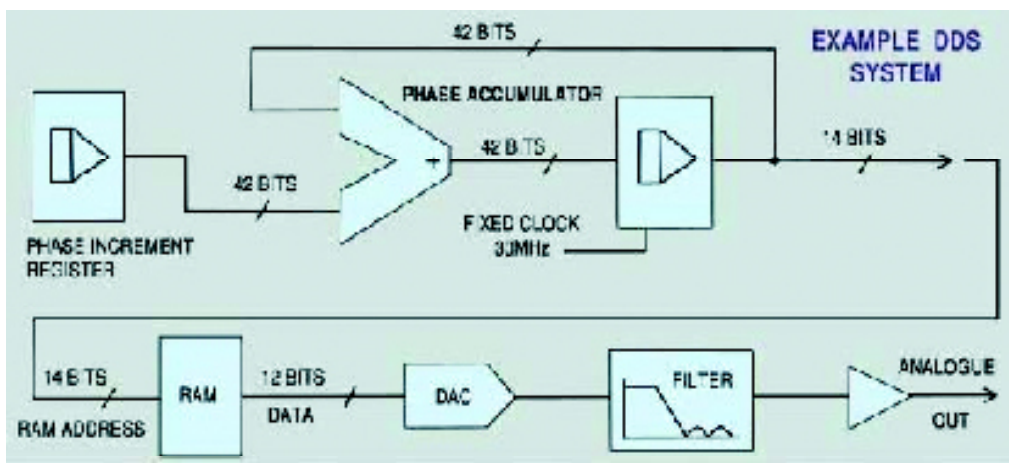

Direct Digital Synthesis (DDS) function generator

Basic principle:

DDS function generators generate periodic signals at precise frequencies by choosing samples in the memory rather than producing all the samples of a signal. This technique offers exceptional accuracy and stability, high spectral purity, low noise and excellent frequency agility. It is possible to modify the frequency without phase discontinuity.

It is important to note that signal generation with the DDS method differs significantly from the method used by an arbitrary signal generator. For arbitrary signal generation, each sample of the signal period built and stored in the memory is generated sequentially.

For signals generated with DDS technology, a single signal period is stored in the memory, but only certain samples are generated to create the waveform and the required frequency, as shown in the illustration below:

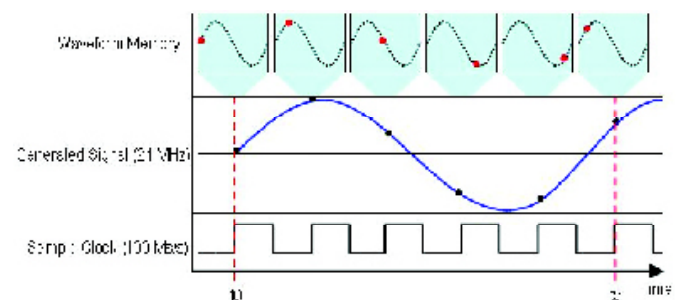

Generation of a 21 MHz signal with direct digital synthesis (DDS)

A few definitions

Signal waveforms

The generator can typically generate sine, triangle and square waveforms, as well as their usual derivatives.

Frequency range (expressed in Hertz (Hz))

This is the difference between the minimum frequency and maximum frequency that the generator is capable of producing. This frequency range is defined for a sinusoidal waveform. It should be noted that a smaller frequency range is usually specified for triangular or square waveforms. The minimum frequency, which may be just a few mHz, is used to simulate slow phenomena (mechanical or physical) or to control slaving (for example, a triangular ramp profile).

Resolution

This is the smallest measurable value difference. It is expressed in digits and its absolute value depends on the frequency range used. For the GX320, for example: 5-digit resolution at 20 MHz corresponds to a 1 kHz increment.

Frequency accuracy

This corresponds to the difference between the true value of the signal's frequency and the value displayed. It mainly depends on the quality of the oscillator used, for which short-term and long-term stabilities are defined, expressed in ppm (parts per million). For example, for the GX320: +/- 20ppm when $F > 10$ kHz.

SWEEP function

The "SWEEP" function can be used to generate a frequency sweep in rising or falling mode. This sweep can be controlled by the generator according to a linear or logarithmic law or on the basis of an external sawtooth or triangular signal applied via a dedicated BNC connection.

Types of modulation



AM: Amplitude Modulation

FM: Frequency Modulation

FSK function: Frequency SKip controlled internally or externally.

PSK function: "Phase SKip" whose value is controlled by an internal or external command signal.

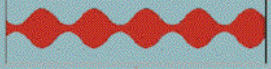
BURST function

Affichage	Description	
20% AM FM	Modulation de l'amplitude de 20 %	
80% AM FM	Modulation de l'amplitude de 80 %	
AM FM	Modulation de fréquence	

The BURST function can be used to generate pulse trains: users define the train generation period and the number of pulses in the train.

It also provides a means of generating a signal with a very large duty cycle (1 brief pulse with a long repetition period).

GATE function

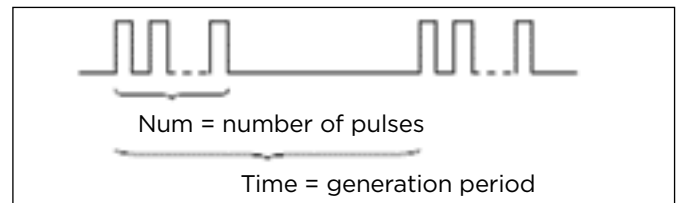

This superimposes over the current function a start/stop command for the AC component of the MAIN OUT signal. This function can be controlled internally or by a TTL signal injected on a dedicated BNC connection.

MASTER/SLAVE function

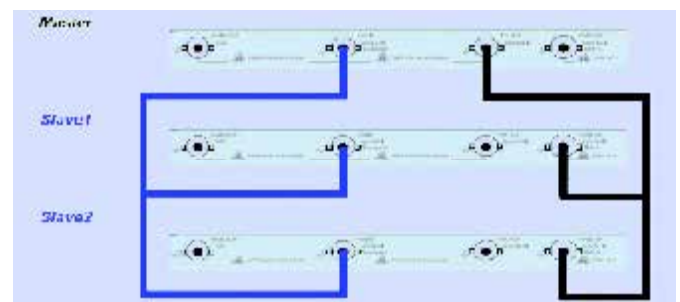

This can be used to synchronize several GX 320s set up in a "cascade" arrangement. The generator used as the "Master" supplies the other "Slave" instruments with the clock (Clk) and a synchronization signal (Ctrl). This enables all the generators to start up at the same time and allows users to control their phase offset.

Selection guide

Function generators



Specifications	GX305	GX310	GX320
Number of channels	1	1	1
Max. frequency (MHz)	5	10	20
Display	LCD (125 x 45 mm) - 5 digit		
Signal waveforms	sine, triangle, square & logic+TTL		
Sweep	•	•	•
AM/FM modulation			•
FSK/ASK function			•
BURST function			•
GATE function			•
MASTER/SLAVE function			•
Frequency meter	100 MHz		
Arbitrary function			
SX-GENE software			
Easywave software			
Pages	86-87		

Arbitrary function generators



Specifications	GX1025	GX1050	DOX3104 DOX3304
Number of channels	2	2	1
Max. frequency (MHz)	25	50	25
Display	3.5" colour TFT		
Signal waveforms	sine, triangle, square, ramp, pulse, white noise, Arb		
Sweep	•	•	
AM/FM modulation	•	•	
FSK/ASK function	•	•	
BURST function	•	•	
GATE function	•	•	
MASTER/SLAVE function			
Frequency meter	200 MHz		
Arbitrary function	•	•	•
SX-GENE software	•	•	
Easywave software			•
Pages	88-89		62

LABORATORY INSTRUMENTS



DDS function generators

GX 305, GX 310 & GX 320

Multi-function, stand-alone, innovative laboratory generators-testers!

Ergonomics: uniquely easy to read!

The GX generators have a large LCD screen (125 x 45 mm) offering exceptionally easy reading thanks to the main display's 5 digits 20 mm high. In addition, the GX generators can simultaneously display all the parameter settings (VDC, V_{RMS} or V_{pp}, waveform, etc.).



- Frequency range from 0.001 Hz to 10 MHz (GX310) or 20 MHz (GX320)
- DDS technology with a frequency accuracy of +/-20 ppm
- Adjustment of stable frequency to the nearest digit
- "Logic signal" function for direct adjustment of the high and low levels (TTL, CMOS, etc.)
- 100 MHz frequency meter, 300V CAT I
- Versions programmable via USB link with the standard SCPI protocol
- AM/FM modulation (GX320)
- GATE, BURST, FSK and PSK functions (GX320)
- Storage of 15 complete instrument configurations (GX320)

Specific innovative function: Adjustable-phase synchronisation of several generators in a cascade arrangement (GX320).

Synchronization of several generators in a cascade arrangement

The "SYNC" function on the GX 320 allows several generators to be set up in a cascade arrangement to make a variable-phase multiple-signal generator. A first GX 320, used as the "Master", provides the other "Slave" instruments with the clock used to generate the signals. It also supplies the synchronizing pulse to start all the instruments simultaneously. In this way, the phase shift of each signal is controlled.

GX 320 Master



GX 320 Slave 1



GX 320 Slave 2

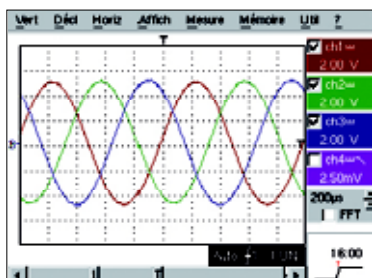

Example 1: simulation of a three-phase signal

- Channel 1: master (0°)
- Channel 2: slave1 (120°)
- Channel 3: slave2 (-120°)

Example 2: Fourier synthesis

Synchronization of the generators (3 in this example) allows simulated synthesis of a square signal from its primary harmonics.

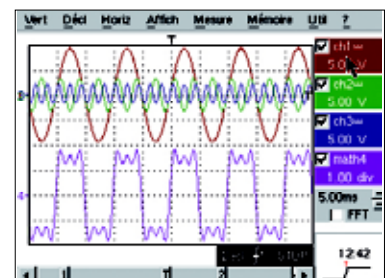



Specifications		GX 305 / GX 310	GX 320
Human-machine interface			
Display	LCD (125 x 45 mm) - Adjustable brightness - Frequency display with 5 digits 20 mm high		
Adjustment of signal parameters	Continuous by encoder, auto-ranging for Frequency and Level, selection of increment digit (F, P, N, etc.)		
BNC output terminals on front panel	TTL & Sweep Out outputs	TTL, Sweep, Clock and Synchro outputs	
BNC input terminals on front panel	VCF in input	VCG, Gate; Clock and Synchro inputs	
Continuous signal generation			
Frequency	0.001 Hz to 10.000 MHz (9 ranges - GX 305) 0.001 Hz to 10.000 MHz (10 ranges - GX 310)	0.001 Hz to 20.000 MHz (11 ranges)	
Resolution / Accuracy	5-digit display - resolution from 1 mHz to 1 kHz depending on range / 10 kHz, ± 30 ppm for F < 10 kHz		
Amplitude	1 mV to 20.0 Vpp with open circuit in 3 automatic ranges -3-digit display Vpp or V _{RMS} - Max. resolution 1 mV		
Flatness	< 5 % for 1 mHz < F < 10 MHz, and ± 0.5 dB typ. up to 20 MHz (GX 320) (specs for a level from 0.1 Vpp to 20 Vpp)		
Signal form	Sine / Triangle (max. frequency 2 MHz) / Square & "LOGIC" / TTL output		
Frequency sweep			
Modes	LIN (linear) or LOG (logarithmic)		
INT internal sweep	"Sawtooth" or "Triangle" mode - Unlimited span between "F Start" & "F Stop" Sweep time adjustable from 10 ms to 100 s		
EXT external sweep	Sweep by signal < 15 kHz, amplitude ± 10 V		
Modulation			
Internal AM modulation	Modulation by a 1 kHz sine signal Modulation rate 20 % or 80 %		
External AM modulation	Modulation by a signal < 5 kHz, with amplitude ± 10 V for 0 to 100 % modulation (VCG IN)		
Internal FM modulation	Modulation by a 1 kHz sine signal Unlimited span between "F Start" & "F Stop"		
External FM modulation	Modulation by a signal < 15 kHz Amplitude ± 10 V (VCG IN)		
SHIFT K function	Frequency hop, internal or external phase jump		
Burst function			
Internal BURST	1 to 65,535 pulses Period of pulse trains 10 ms to 100 s		
External BURST	1 to 65,535 pulses - Synchro/Period by a TTL signal with frequency < 1 MHz (VCG IN)		
Gate function	Validation of AC component from "Main Out" by a TTL signal with frequency < 2 MHz (GATE IN)		
Synchro function			
Cascade configuration of several GX 320s	Maximum frequency of generated signals 100 kHz Adjustment of phase shift to ± 180° (resolution 1°)		
External frequency meter			
Measurement range / accuracy	5 Hz to 100 MHz / ± 0.05 % + 1 digit		
Safety / max. admissible voltage	300 V CAT I / 300 V _{RMS}		
General specifications			
Configuration memories	Storage/Recall of 15 complete instrument configurations		
Communication interface	"USB A/B" link for the programmable versions (P) and Ethernet for the GX 320-E		
Mains power supply	230 V ± 10 % (or 115 V ± 10 %) - 50/60 Hz - 20 VA max. - Removable lead		
Safety / EMC	Safety as per IEC 61010-1 (2001) - EMC as per EN 61326-1 (2004)		
Mechanical specifications	227 (L) x 116 (H) x 180 (W) mm - Weight 2.8 kg		
Warranty	3 years		

Standard state at delivery

- Standard versions
 - 1 function generator, 1 mains power cable, 1 CD-Rom containing: 1 user manual in 5 languages, 1 programming manual in FR + EN, LabWindows CVI / LabView drivers
- Programmable versions
 - 1 function generator, 1 mains power cable, 1 CD-Rom containing: 1 user manual in 5 languages, 1 programming manual in FR + EN, LabWindows CVI / LabView drivers, 1 USB A/B cable - Ethernet version - The same + 1 Ethernet cable

Available accessories

See page 114

Accessories and replacement parts

- AG1066-Z: set of 2 BNC-banana leads with rear connection
 HX0106: Set of 2 BNC-BNC leads 1 m long
 HX0107: Set of BNC-banana adapters
 HA2004-Z: Set of 3 BNC T-fittings

References to order

- GX305: 5 MHz function generator
 GX310: 10 MHz function generator
 GX310-P: Programmable 10 MHz function generator
 GX320: 20 MHz function generator
 GX320-E: Programmable 20 MHz function generator



For further details...

LABORATORY INSTRUMENTS

DDS function generators

GX1025 & GX1050

These multi-function, communicating laboratory generators-testers with built-in frequency meter are ideal for all R&D lab, testing and production applications, as well as for technical training and higher education.



GX 1025, 25 MHz



GX 1050, 50 MHz



GX 1050 (rear view)

- Large 320 x 240 mm TFT LCD screen with high contrast for better visibility, intuitive front panel and simple use
- DDS technology on 2 outputs for coupling or duplication
- Generation of standard signals such as sine, square and triangle, as well as more complex signals: pulse, ramp or white noise
- Generation of arbitrary signals which are precise, stable and pure, with low distortion at a sampling rate of 125 MS/s on 14-bit resolution
- Internal SWEEP wobble modulation: external or manual, linear or logarithmic
- The integrated AM, FM, PM, ASK and FSK modulation functions can be used to generate modulated signals very easily without an independent modulation source
- Memory depth of up to 16 kpoints, allowing reconstruction or simulation of any type of complex signal
- Generator user interface and integrated help in English
- USB interface on front panel for data storage
- USB interface on front panel for programming and control of the instrument via the SX-GENE software

SX-GENE v2.0 can be used to control a GX 1025 or GX 1050 arbitrary function generator, save and recall configurations and generate arbitrary signals.

It allows:

- Data transfer in .arb files (from the generator to the PC)
- Recovery of a signal from a METRIX® oscilloscope curve (.trc file transferred into the generator)
- Configuration of the generator (.cfg)
- Recovery of an arbitrary signal stored in one of the generator's 10 memory locations

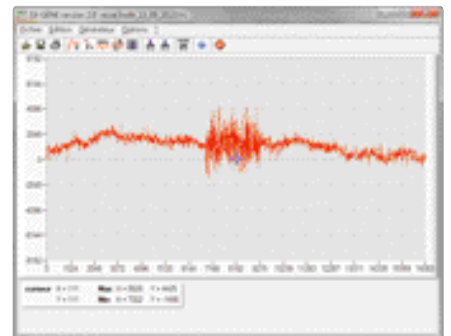

Specifications		GX1025	GX1050
Human-machine interface			
Display	Large high-contrast 3.5" TFT colour screen / Resolution 320 x 240		
Controls on front panel	18 direct-access buttons, 1 rotary button		
Adjustment of signal parameters	Continuous adjustment by the encoder and/or numeric keypad		
BNC output terminals on front panel	Generator outputs 1 & 2 - Separate adjustment (waveform, f, phase, amplitude, etc.), coupled or duplicated		
BNC I/O terminals on rear panel	TTL-compatible trigger and synchronization outputs		
Continuous signal generation			
Signal types	Sine, Square, Triangle, Ramp, Pulse, White Noise, Arbitrary Signal (48 pre-installed waveforms)		
Arbitrary signal generation			
Resolution / Sampling rate	14 bits / 125 MS/s		
Memory	16k memory depth (512k on CH1 only) - Storage of predefined or specific signals on USB key		
Editing of signals with SX-GENE	Acquisition, transfer & modification of a signal acquired from an oscilloscope (OX6000, OX7000, SCOPEin@BOX) Graphical or mathematical editing with the SX-GENE software		
Signal frequency			
Frequency range	Sine from 0.001 MHz to 25.000 MHz, Triangle 300 kHz, Noise and Square 25 MHz, Pulse 10 MHz, Arbitrary Signals 5 MHz	Sine from 0.001 MHz to 50.000 MHz, Triangle 300 kHz, Noise and Square 50 MHz, Pulse 20 MHz, Arbitrary Signals 5 MHz	
Resolution / accuracy	7-digit display - resolution from 1 MHz to 1 kHz depending on frequency range ± 20 ppm for $F > 10$ kHz, ± 30 ppm for $F < 10$ kHz		
Long-term drift	± 100 ppm / year		
Temperature coefficient	< 5 ppm / °C		
Amplitude			
Voltage levels	Output 1 = 2 mVpp - 10 Vpp 50 Ω 2 mVpp - 20 Vpp (open circuit) Output 2 = 2 mVpp - 3 Vpp (50 Ω) 2 mVpp - 6 Vpp (open circuit)		
Flatness	< 0.1 dB for $f < 100$ kHz		
Vdc offset	Output 1 = ± 10 Vdc (open circuit), Output 2 = ± 3 Vdc (open circuit) - accuracy $\pm 1\%$ ± 1 mV		
Impedance / Protection	50 Ω / Protection against short-circuits		
Signal characteristics			
Sine	Distortion $< 0.2\%$ typical for $f < 20$ kHz, and harmonics < -50 dBc for DC $< f < 25$ MHz (level < 1 Vpp)		
Triangle (max. frequency 2 MHz)	Linearity error $< 1\%$ max		
Square & pulse	Rise time < 12 ns (typ.) - Duty cycle 20-80% (DC $< f < 20$ MHz) - Pulse 20 ns to 2,000 s		
Modulation (internal or external source)			
AM modulation	Carrier: Sine, Square, Triangle, Arbitrary (except DC) Modulated signals: Sine, Square, Ramp, Noise, Arbitrary (2 MHz-20 kHz) Modulation depth: 0% to 120%		
FM modulation	Carrier: Sine, Square, Triangle, Arbitrary (except DC) Modulated signals: Sine, Square, Ramp, Noise, Arbitrary (2 MHz-20 kHz) Modulation depth: 0% to 120%		
	Frequency offset: 0 to 12.5 MHz	Frequency offset: 0 to 25 MHz	
FSK modulation	Carrier: Sine, Square, Triangle, Arbitrary (except DC) Modulated signals: 50% of duty cycle (2 MHz to 50 kHz)		
ASK modulation	Carrier: Sine, Square, Triangle, Arbitrary (except DC) Modulated signals: 50% of duty cycle (2 MHz to 50 kHz)		
PM modulation	Carrier: Sine, Square, Triangle, Arbitrary (except DC) Modulated signals: Sine, Square, Ramp, Triangle, Noise, Arbitrary (2 MHz-20 kHz) Phase offset: 0 to 360°		
Other functions			
Sweep	Carrier: Sine, Square, Ramp, Triangle, Arbitrary (except DC) - Type: Linear/Logarithmic Direction: Increasing or Decreasing - Sweep time: 1 ms to 500 s - Trigger: Manual, External, Internal		
Burst	Signals: Sine, Square, Ramp, Arbitrary (except DC) - Type: Short (1-50,000 cycles), Infinite, Gate - Phase start/stop: -180° to +180° - Internal period: 1 μ s to 500 s $\pm 1\%$		
External frequency meter			
Measurement range / resolution	100 mHz to 200 MHz		
Sensitivity / Input impedance	20 mVRMS for 100 mHz $< f < 100$ MHz, 40 mVRMS beyond / 1 M Ω		
General specifications			
Data storage	Storage of predefined or specific signals and complete instrument configurations on USB key		
Communication interface	USB Device, USB host		
Software	The SX-GENE software can be downloaded free of charge from our support website, along with the LV and LW drivers		
Mains power supply	100-240 VACRMS 45-440 Hz CAT II - < 30 W		
Mechanical specifications	229 mm x 105 mm x 281 mm - 2.8 kg		
Warranty	1 year		

Standard state at delivery

1 GX delivered with 1 mains power cable, 1 USB cable, 1 user manual, 1 programming manual on CD-Rom and the SX-GENE v2.0 software

References to order

GX1025: 25 MHz arbitrary function generator
GX1050: 50 MHz arbitrary function generator

Available accessories

See page 114

Power supply basics

DC power supplies offer constant, controlled current and voltage output. A power supply can be seen as an AC/DC converter which takes energy from the electrical network (230 V/50 Hz) and passes on part of that energy.

The linear technology used in our AX 5xx power supplies is based on a toroidal transformer which reduces the weight and improves efficiency while providing the following features:

- Protection against short-circuits, overloads and overheating
- Double-well safety output terminals and double-well male safety earth terminal
- Toroidal transformer compliant with the EN60742 standard with outputs double-insulated in relation to the mains supply: no forced ventilation to reduce noise and low radiation
- Serial or parallel coupling of the outputs and loop control of the outputs with the Tracking mode.

A programmable DC power supply is adjustable and offers multiple functions. These power supplies are usually equipped with independent outputs:

- With an adjustable voltage level
- or a fixed voltage.

The power supply can be used to power logic circuits for voltage or current requirements of different levels.

Output modes

- Independent mode: the output voltage and current on each channel are controlled separately. The level of insulation between the output terminal and the chassis, or between output terminals, is fixed.
- Tracking mode: the two CH1 and CH2 outputs are automatically connected in series or in parallel.

Coupling

- Series: the output voltage is doubled
- Parallel: the output current is doubled.

Selection guide	AX 501	AX 502	AX 503	AX 1360-P
1 channel	•	•	•	•
2 channels		•	•	•
2 channels + 1 fixed			•	•
Tracking mode		•	•	•
Programmable				•
Ventilation				•
Memory				•
USB				•

AX 501, AX 502, AX 503 & AX 503F

As well as being particularly rugged, these power supplies are also lightweight, economical and based on the latest technology!
The AX 501, AX 502 and AX 503 laboratory power supplies with 1, 2 or 3 outputs offer electronic limitation of the current in the event of short-circuit and temperature control in the event of overload or overheating. Their linear technology is based on a toroidal transformer which halves their weight and improves their efficiency.

- Linear technology: stability, low noise, good response to current demand
- Active protection against short-circuits, overloads and overheating
- Outputs with double insulation in relation to the mains
- Series or parallel output coupling for generating up to 60 V / 2.5 A or 30 V / 5 A
- Coupling of the two 30 V outputs in "tracking" mode in order to adjust them simultaneously (master/slave)
- Adjustable current limitation on the 30V outputs
- A third adjustable 2.7 V-5.5 V/5 A output on the AX 503 can be used to power logic circuits (TTL/CMOS)
- Compact and lightweight
- Dual-well safety terminals
- An earth terminal with reversed polarity to avoid connection errors

Specifications	AX 501	AX 502	AX 503	AX 503F
Technology	Linear			
Display	Green and red LEDs - 3 digits			
Outputs	1 x (30 V/2,5 A)	2 x (30 V/2,5 A)	2 x (30 V/2,5 A) 1 x (2,7 to 5,5 V/5 A)	2 x (30 V _{oc} /2,5 A fixed) 3,3 V _{oc} fixed/5 A fixed
Output coupling	Series or parallel			
Output tracking	Yes ("track" mode)			
Special features	Electronic protection against short-circuits, overloads and overheating. Output double insulated from mains Toroidal transformers (no forced ventilation and low emissions) Double-well safety terminals			
IEC 61010 - 1 safety	CAT I, 100 V			
Power supply	110, 230 V			
Dimensions (H x L x W)	120 x 225 x 270 mm			
Weight	4 kg	4,5 kg	6 kg	
Warranty	3 ans			

Standard state at delivery

1 AX power supply, 1 power cable,
1 user manual

Specific accessory

P01295073A - Reverse-polarity earthing
cable (green/yellow)

References to order

AX0501A: AX501
AX0502A: AX502
AX0503A: AX503
AX0503F: AX503F

Available accessories

See pages 102 and 103



For further details...

Programmable power supply

AX1360-P

Performance and simplicity at the best price!

- 2 adjustable outputs (0-30 V) and 1 selectable fixed output (2.5 V / 3.3 V / 5 V)
- Bright colour display of the currents and voltages simultaneously on 3 digits
- Simplified use thanks to serial or parallel coupling without leads
- Quicker setup with 4 configurations available for recall on the front panel
- High stability and low drift over time, whatever the mode
- Protection against voltage surges, overheating and short-circuits
- Ventilation control according to the output power
- USB communication



Specifications		AX 1360-P
Frequency		
Display	Digital with LEDs - Simultaneous voltage and current in colour	
Number of outputs	3	
Voltage control		
Output 1	0 - 30 V	
Output 2	0 - 30 V	
Output 3	2.5 V / 3.3 V / 5 V	
Current control		
	Independent	Parallel
Output 1	3 A	6 A
Output 2	3 A	6 A
Output 3	3 A	-
Accuracy		
Voltage	±(0.5 % reading + 2 digits)	
Current	±(0.5 % reading + 5 digits)	
Resolution		
Voltage	10 mV (0 to 9.99 V) - 100 mV (10 to 30 V)	
Current	10 mA	
Ripple and noise		
Voltage	< 1 mVRMS	
Temperature coefficient		
Voltage	< 300 ppm / °C	
On-load		
	Independent and parallel	
Voltage control	< 0.1 % +5 mV	
Current control	< 0.2 % +3 mA	
Protection		
Short-circuits	Current limitation and visual indicated by red LED	
Overcurrent	Fuse	
"SAVE/RECALL" function		
No. of stored configurations	4	
Technical Specifications		
Current and voltage adjustment	Output 1 and 2 by potentiometers, Output 3 by switch	
Interface / Software	USB	
Mains power source	110 V - 220 V / 50 Hz - 60 Hz	
Safety / Protection	IEC 61010-1 300 V CAT II / Fuse	
Mechanical specifications	Dimensions: 310 x 250 x 150 mm - Weight: 7.5 kg	
Warranty	1 year	

Standard state at delivery

AX1360-P: 1 programmable power supply, 1 power cable, 1 USB cable, 1 CD-Rom containing the user manual and the LV/CVI drivers

References to order

AX1360-P

Available accessories

See pages 102 and 103

For further details...



Training boxes and shunts

■ IEC61010-1 -150V CAT II, 50V CAT III

■ Selection by rotary switch

Simple resistance boxes

P03197521A	0.1 to 1 Ω
P03197522A	1 to 10 Ω
P03197523A	10 to 100 Ω
P03197524A	100 to 1,000 Ω
P03197525A	1 to 10 k Ω
P03197526A	10 to 100 k Ω
P03197527A	100 to 1,000 k Ω
P03197528A	1 to 10 M Ω

4, 5, 6 and 7-decade resistance boxes

P01197401	BR 04 : 4 decades 1 Ω to 10 k Ω
P01197402	BR 05 : 5 decades 1 Ω to 10 k Ω
P01197403	BR 06 : 6 decades 1 Ω to 10 k Ω
P01197404	BR 07 : 7 decades 1 Ω to 10 k Ω

Coupling jumpers

P01101892A	19 mm spacing - \varnothing 4 mm - 36 A
------------	---



Measurement shunts	Max. current	Voltage drop
HA030-1 (Class 0.5 compliant with the IEC 61010-1 standard, 600 V CAT III)	30 A	300 mV
HA050	50 A	100 mV
HA050-1	50 A	50 mV

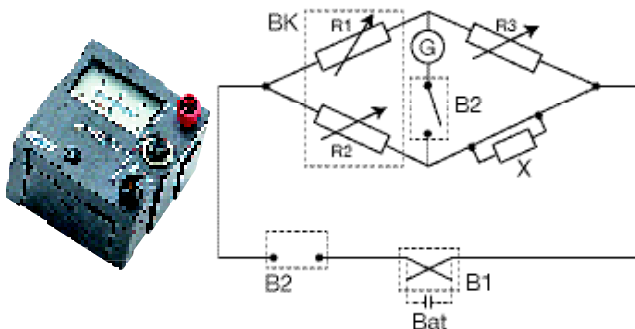

Capacitance decade boxes

P01199613A	0.01 to 0.1 mF
P01199612A	0.1 to 1 mF
P03199611A	1 to 10 mF
P01197421	BC 05: 5 decades - 1 nF to 10 μ F

Null galvanometer

P03197611A	Bandwidth: 60 and 100 MHz Dial with anti-parallax mirror, accuracy $\pm 2.5\%$ 2 calibres by pushbutton
------------	---

Ratio boxes

P03197531A	7 ratios: from 1/1,000 to x 1,000, accuracy $\pm 0.2\%$ for Wheatstone bridge application
------------	---

Double changeover switch box

P03197529A	2 switches with make/break/non-locking make
------------	---

Simple changeover switch box

P03197530 A	1 changeover switch with make break/reverse make
-------------	--

Inductance box

P01197451	BL 07: 7 decades - 1 μ H to 10 H
-----------	--------------------------------------



G = null galvanometer

BK = K ratio box with $K = R2/R1$

R3 = resistance box

X = resistance to be measured with $X = K \times R3$

B1 = simple changeover switch box

B2 = double changeover switch box

Bat = power supply



Multi-function calibrator

CX 1651

Designed for measuring instrument manufacturers seeking to calibrate their instruments, the CX 1651 is particularly accurate and stable.

Based on a new concept, the CX 1651 generates:

- standard electrical parameters for temperature or energy applications
- non-harmonic signals for testing equipment when the distortion on the input signals is non-null.

It can be used to calibrate a wide variety of instruments:

- Multimeters
- Analogue instruments
- Switchboard equipment
- Current clamps
- Portable calibrators
- Wattmeters
- Electrometers
- Oscilloscopes
- Thermometers
- Loggers, etc.



Specifications		CX 1651	
Voltage	DC	6 ranges from 0 V to 1,000 V	
	AC	6 ranges from 1 mV to 1,000 V	
Current	DC	6 ranges from 1 μ A to 20 A	
	AC	6 ranges from 1 μ A to 20 A	
Resistance	(4-wire set-up)	10 ranges from 0 Ω to 50 M Ω	
Capacitance	(4-wire set-up)	9 ranges from 900 pF to 50 μ F	Maximum voltage supported by the load: 8 Vpk
Frequency	PWM (pos, neg, sym)	0.1 Hz to 100 kHz	
	HF (rise time < 5 ns)	0.1 Hz to 100 kHz	
Power Energy	DC	Voltage from 200 mV to 240 V Current from 2 mA to 10 A	Acquisition time in energy mode 10 s to 1,999 s
	AC	Voltage from 200 mV to 240 V Current from 2 mA to 10 A Frequency from 40 Hz to 400 Hz Power factor -1 or +1 Phase from 0 to 360°	
Temperature sensor	Thermocouple	R, S, B, J, T, E, K, N Ranges from -250 °C to +1,820 °C	
	RTD sensor	Pt 1385, Pt 1392, Ni Ranges from -200 °C to +850 °C	

Multimeter

Function	Range	Accuracy
V _{DC} (DC voltage)	0 - \pm 12 V	0.01 % + 100 μ V
mV _{DC} (DC voltage)	0 - \pm 2,000 mV	0.01 % + 10 μ V
mA _{DC} (DC current)	0 - \pm 25 mA	0.02 % + 1 μ A
FREQ (Frequency)	1 Hz - 15 kHz	0.005 %
R4W (Resistance)	0 - 2 k Ω	0.02 % + 100 m Ω
TRTD (RTD sensors)	-150 °C - +600 °C	0.1 °C
TTC (TC sensors)	-250 °C - +1,820 °C	0.4 - 4 °C
SGS (deformation)*	Depending on sensor	0.01 % + 10 μ V + sensor accuracy

Standard state at delivery

1 multi-function calibrator delivered with 1,000 V / 20 A test cables (x 2), 1 Option 40 cable adapter (Canon 25/2 x banana cable adapter, 1 m), 1 Option 60 cable adapter (Canon 25/4 x banana cable adapter, 1 m), 1 Option 70 cable adapter (adapter for resistances on four terminals), 1 RS 232 cable, 1 power cable, 2 spare fuses, 1 test report and 1 user manual.

Reference to order

CX1651: 1 CX 1651 multi-function calibrator

Available accessories

See pages 102 and 103



For further details...



Accessories for multimeters

Choosing your current clamp	97
AC current clamps	98
Flexible sensor for AC current	99
AC/DC current clamps	100
Current clamps for specific requirements	101
Measurement leads	102
Test probes	102
Adapters for temperature measurement	103
K thermocouple sensors	104
Pt100 platinum probe	105
Transport and protection	106

Accessories for oscilloscopes

Choosing your voltage probe	107
Electronic voltage probes	108
High-Voltage / High-Frequency probe	109
General-purpose probes	109
Differential voltage probes	110
Insulated AC current probes	112
Insulated AC/DC current probes	112
Flexible current probes	113
Coaxial accessories	114
Protection and transport accessories	115
Mechanical adaptations	115

Fuses 116

Choosing your current clamp

There are multiple criteria for choosing a current clamp. The approach below helps to specify your requirements and guide you naturally towards the most suitable model for your application. The CHAUVIN ARNOUX Catalogue contains a complete list of the clamps available.

To choose your clamp, we advise you to follow the logic presented below:

Measurement input

- Measurement of DC or AC currents? (see AC or AC/DC clamps table)
- Measurement of low, medium or high currents? On small wires or large cables? ... only choose the families with the right shapes and dimensions

Output - Connection technology

- What instrument will the clamp be connected to? (see Output/Connection column to choose a clamp whose signal and connection technology are compatible)

Specific features



- What are your other criteria? (see the Specific Features column to check whether the clamp chosen perfectly matches your requirements)



Specifications	Accessories for multimeters: clamps				
AC current measurement	•				
AC current measurement with flexible probe		•			
AC/DC current measurement			•		
Leakage current measurement				•	
Process current measurement					•
Pages	98	99	100	101	101
Selection guide on pages	28-29				

	Accessories for multimeters: Connection				Safety
Leads and test probes ø 4 mm	•				
4 mm banana connection accessories		•			
Adapters and probes			•		
Transport and protection accessories				•	
Fuses					•
Pages	102	103	102-105	106-107	107
Software: see pages	32-33				

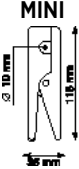
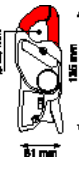
AC current clamps

Series	Model	Input				Output connections			Specific features					To order			
		Measurement range				Current	Voltage	Lead + Ø4 mm safety plugs	Female sockets Ø4 mm	BNC connector (coaxial)	Transformation ratio (input/output)	Output protected against overvoltages	Automatic DC zero		Power measurement (low phase shift)	Bandwidth (frequency in Hz)	Typical accuracy
Very low current	Low current	Medium current	High current	AC	DC												
 MINI	MINI 01		2 to 150 A			•	0.15 A _{AC}				1,000/1	•			48 Hz ... 500 Hz	≤ 2.5 %	P01105101Z
	MINI 02	50 mA to 100 A				•	0.15 A _{AC}				1,000/1	•	•		48 Hz ... 10 Hz	≤ 1 %	P01105102Z
	MINI 05	5 mA to 10 A 1 A to 100 A					•		10 V _{AC} 0.1 V _{AC}			1 mA / 1 mV 1 A / 1 mV			48 Hz ... 500 Hz	≤ 3 % ≤ 2 %	P01105105Z
 MN	MN12		0.5 A to 240 A			•		2V _{AC}			1 A / 10 mV			40 Hz ... 10 kHz	≤ 1 %	P01120405	
	MN08		0.5 A to 240 A			•					1,000/1			40 Hz ... 10 kHz	≤ 1 %	P01120401	
	MN09		0.5 A to 240 A			•					1,000/1			40 Hz ... 10 kHz	≤ 1 %	P01120402	
	MN14		0.5 A to 240 A			•					1 A / 1 mV			40 Hz ... 10 kHz	≤ 1 %	P01120416	
	MN89		0.5 A to 240 A				•				1 A / 100 mV			40 Hz ... 10 kHz	≤ 2 %	P01120415	
 C	C100	0.1 A to 1,200 A				•					1,000/1			30 Hz ... 10 kHz	≤ 0.5 %	P01120301	
	C103	0.1 A to 1,200 A				•					1,000/1	•		30 Hz ... 10 kHz	≤ 0.5 %	P01120303	
	C106	0.1 A to 1,200 A				•					1 A / 1 mV			30 Hz ... 10 kHz	≤ 0.5 %	P01120304	
	C107	0.1 A to 1,200 A				•					1 A / 1 mV			30 Hz ... 10 kHz	≤ 0.5 %	P01120305	

Standard state at delivery

1 clamp and 1 user manual



MINI 05



C103





MN89



MN09

Flexible probes for AC current

Series	Model	Input				Output connections			Specific features					Typical accuracy	To order		
		Very low current	Low current	Medium current	High current	AC	DC	Current	Voltage	Lead + Ø4 mm safety plugs	Female sockets Ø4 mm	BNC connector (coaxial)	Transformation ratio (input/output)			Output protected against overvoltages	Automatic DC zero
	MA110 3-30-300-3000/3 (17 cm / Ø 4.5 cm)	0.02 A - 3A 0.5 A .. 30 A 0.5 A .. 300 A 0.5 A .. 3000 A	•					3 V _{AC}	•			1 V/A 100 mV/A 10 mV/A 1 mV/A		•	10 Hz .. 10 kHz 10 Hz .. 20 kHz 10 Hz .. 20 kHz 10 Hz .. 20 kHz	≤1%	P01120660
	MA110 3-30-300-3000/3 (25 cm / Ø 7 cm)	0.02 A - 3A 0.5 A .. 30 A 0.5 A .. 300 A 0.5 A .. 3,000 A	•					3 V _{AC}	•			1 V/A 100 mV/A 10 mV/A 1 mV/A		•	10 Hz .. 10 kHz 10 Hz .. 20 kHz 10 Hz .. 20 kHz 10 Hz .. 20 kHz	≤1%	P01120661
	MA110 3-30-300-3000/3 (35 cm / Ø 10 cm)	0.02 A - 3A 0.5 A .. 30 A 0.5 A .. 300 A 0.5 A .. 3,000 A	•					3 V _{AC}	•			1 V/A 100 mV/A 10 mV/A 1 mV/A		•	10 Hz .. 10 kHz 10 Hz .. 20 kHz 10 Hz .. 20 kHz 10 Hz .. 20 kHz	≤1%	P01120662
	A110 3-30-300-3000/3 (45 cm / Ø 14 cm)	0.02 A - 3A 0.5 A .. 30 A 0.5 A .. 300 A 0.5 A .. 3,000 A	•					3 V _{AC}	•			1 V/A 100 mV/A 10 mV/A 1 mV/A		•	10 Hz .. 10 kHz 10 Hz .. 20 kHz 10 Hz .. 20 kHz 10 Hz .. 20 kHz	≤1%	P01120630
	A110 3-30-300-3000/3 (80 cm / Ø 25 cm)	0.02 A - 3A 0.5 A .. 30 A 0.5 A .. 300 A 0.5 A .. 3,000 A	•					3 V _{AC}	•			1 V/A 100 mV/A 10 mV/A 1 mV/A		•	10 Hz .. 10 kHz 10 Hz .. 20 kHz 10 Hz .. 20 kHz 10 Hz .. 20 kHz	≤1%	P01120631
	A110 30-300-3000-30000/3 (120 cm / Ø 38 cm)	0.05 A - 3A 0.5 A .. 30 A 0.5 A .. 300 A 0.5 A .. 3,000 A	•					3 V _{AC}	•			100 mV/A 10 mV/A 1 mV/A 0.1 mV/A		•	10 Hz .. 10 kHz 10 Hz .. 20 kHz 10 Hz .. 20 kHz 10 Hz .. 20 kHz	≤1%	P01120632

Standard state at delivery

1 flexible current sensor delivered with 2 x 1.5 V AA / LR6 batteries, 1 user manual in 5 languages and 1 safety datasheet

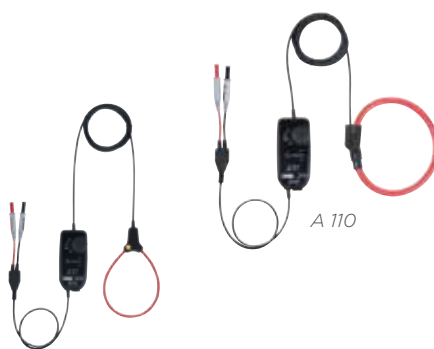

MA 110

A 110

Optional accessories

Mains adapter + µUSB-B cable for MA110/ A110: PO1651023

AC/DC CURRENT CLAMPS

Series	Model	Input				Output connections		Specific features				To order			
		Very low current	Low current	Medium current	High current	AC	DC	Current	Voltage	Lead + Ø4 mm safety plugs*	Transformation ratio (input/output)		Automatic DC zero	Bandwidth (frequency in Hz)	Typical accuracy
K	K2	0.1 to 450 mA _{DC} 0.1 to 300 mA _{RMS} 0.1 to 450 mA peak				•	•		4.5 V _{DC} 3 V _{RMS} 4.5 V peak	•	1 mA / 10 mV		DC to 15 kHz	≤ 1 %	P01120074A
E	E6N	5 mA to 2 A _{DC} 5 mA to 1.5 A _{RMS} 20 mA to 80 A _{AC/DC}				•	•		2 V _{DC} 1.5 V _{AC} 0.8 V _{AC/DC}	•	1 A / 1 V 1 A / 10 mV		DC to 2 kHz DC to 8 kHz	≤ 2 % ≤ 4 %	P01120040A
PAC 1X	PAC 11	0.2 to 40 A _{AC} 0.4 to 60 A _{DC} 0.5 to 600 A _{DC} 0.5 to 600 A _{AC}				•	•		600 mV _{AC/DC}	•	1 A / 1 V 1 A / 10 mV	•	DC to 10 kHz	≤ 1.5 % ≤ 2.5 %	P01120068
	PAC 20	0.5 to 1,000 A _{AC} 0.5 to 1,400 A _{DC}				•	•		1.4 V _{AC/DC}	•	1 A / 1 mV		DC to 5 kHz	≤ 2 %	P01120071
PAC 2X	PAC 21	0.2 to 100 A _{AC} 0.4 to 150 A _{DC} 0.5 to 1,000 A _{AC} 0.5 to 1,400 A _{DC}				•	•		1.4 V _{AC/DC}	•	1 A / 10 mV 1 A / 1 mV	•	DC to 10 kHz	≤ 1.5 % ≤ 2.5 %	P01120069

* Lead + electronic unit with Ø 4 mm safety plugs with 19 mm spacing for the K Series

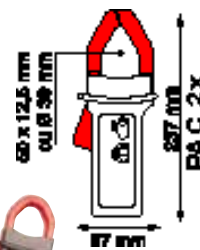
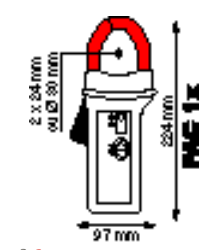
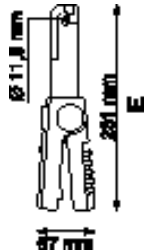
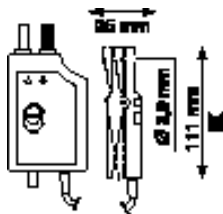

Standard state at delivery

Delivered with 9 V battery and user manual

Optional accessories

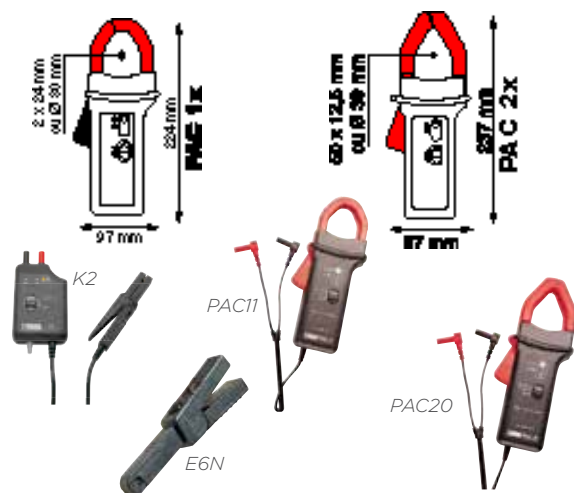

Mains adapter for K: P01101966
Mains adapter for E: P01101965
Mains adapter for PAC: P0110196



Current clamps for specific requirements

Series	Model	Input Measurement range				Output connections				Specific features				To order		
		CVery low current	Low current	Medium current	High current	AC	DC	Current	Voltage	Lead + Ø4 mm safety plugs*	Transformation ratio (input/output)	BNC connector (coaxial)	Automatic DC zero		Output protected against overvoltages	Automatic DC zero

Leakage current measurement

	MN73	10 mA to 2.4 A 100 mA to 240 A			•		2 V _{AC} 2 V _{AC}	•		1 A / 1,000 mV 1 A / 10 mV			40 Hz to 10 kHz	≤ 1 % ≤ 2 %	P01120421
	C173	1 mA to 1.2 A 0.01 A to 12 A 0.1 A to 120 A 1 A to 1,200 A			•		1 V _{AC}	•		1 A / 1 V 10 A / 1 V 100 A / 1 V 1000 A / 1 V			10 Hz to 3 kHz	≤ 0.7 % ≤ 0.3 % ≤ 0.5 % ≤ 0.2 %	P01120309
	B102	500 µA to 4 A 0.5 A to 400 A			•		4 V _{AC} 0.4 V _{AC}	•		1 mA / 1 mV 1 A / 1 mV	•		10 Hz to 1 kHz	≤ 0.5 % ≤ 0.35 %	P01120083

Delivered with user manual

Measurement of process current

	K1	1 mA to 4.5 A _{DC} 1 mA to 3 A _{RMS} 1 mA to 4.5 A peak			•	•	4.5 V _{DC} 3 V _{RMS} 4.5 V peak	•		1 mA / 1 mV			DC to 2 kHz	≤ 1 %	P01120067A
---	-----------	---	--	--	---	---	---	---	--	-------------	--	--	-------------	-------	------------

Delivered with 9 V battery and user manual

* Lead + electronic unit with Ø 4 mm safety plugs with 19 mm spacing for the K Series

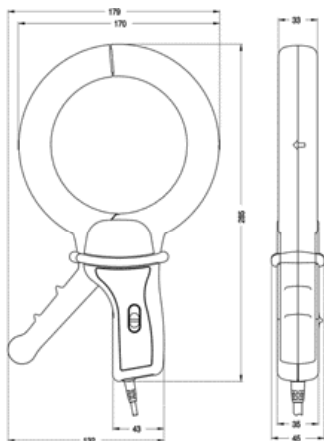

Leads and accessories

Ø 4 mm banana connection accessories

Removable test probes

For CAT IV & CAT III installations
 Set of 2 moulded test probes
 Female plug Ø 4 mm 15 A - CAT IV and CAT III
 1,000 V > P01295454Z

For CAT II and lower installations
 Set of 2 moulded test probes Ø 4 mm
 Female plug Ø 4 mm 15 A - CAT II 300 V
 > P01295458Z

For CAT II and lower installations
 Set of 2 moulded test probes Ø 2 mm
 Female plug Ø 4 mm 15 A - CAT II 300 V
 > P01295460Z

Moulded measurement leads

Set of 2 moulded PVC leads (R/B)
 Insulated straight male plug Ø 4 mm - Insulated
 straight male plug Ø 4 mm 15 A, 1.5 m - 1,000 V
 CAT IV > P01295450Z

Set of 2 moulded PVC leads (R/B)
 Insulated straight male plug Ø 4 mm - Insulated
 elbowed male plug Ø 4 mm 15 A, 1.5 m
 > P01295451Z

Set of 2 moulded silicone leads (R/B)
 Insulated straight male plug Ø 4 mm - Insulated
 straight male plug Ø 4 mm 15 A, 1.5 m - 1,000 V
 CAT IV > P01295452Z

Set of 2 moulded silicone leads (R/B)
 Insulated straight male plug Ø 4 mm - Insulated
 elbowed male plug Ø 4 mm 15 A, 1.5 m
 1,000 V CAT IV > P01295453Z

Standard measurement leads

Set of 2 PVC leads (R/B)
 Insulated straight male plug Ø 4 mm - Insulated
 straight male plug Ø 4 mm 15 A, 1.5 m - 600 V
 CAT IV / 1,000 V CAT III > P01295288Z

Set of 2 PVC leads (R/B)
 Insulated straight male plug Ø 4 mm - Insulated
 elbowed male plug Ø 4 mm 15 A, 1.5 m - 600 V
 CAT IV / 1,000 V CAT III > P01295289Z

Set of 2 PVC leads (R/B). Insulated straight male
 plug Ø 4 mm with rear connection - Insulated
 straight male plug Ø 4 mm with rear connection
 20 A, 2 m - 600 V CAT III > P01295290Z

Built-in test-probe leads

Set of 2 PVC test-probe leads (R/B)
 Insulated straight male plug Ø 4 mm 15 A,
 1.5 m - 1,000 V CAT IV > P01295455Z

Set of 2 PVC test-probe leads (R/B)
 Insulated elbowed male plug Ø 4 mm 15 A,
 PVC 1.5 m - 1,000 V CAT IV > P01295456Z

Set of 2 IP2X PVC leads for multimeter
 Compliant with NF C 18-510 and IEC 61010-
 031+A1:2008 IP2X test probe - Insulated elbowed
 male plug Ø 4 mm 15 A, 1.5 m - 600 V CAT IV
 > P01295461Z

Set of 2 red/black crocodile clips
 15 A - 1,000 V CAT IV > P01295457Z

Set of leads and measurement accessories for
 electricians
 2 x moulded test probes 1,000 V CAT IV
 - 2 red/black moulded PVC leads with straight male
 plug - elbowed male plug 1.5 m 1,000 V
 CAT IV - 2 red/black crocodile clips 1,000 V
 CAT IV - 2 x moulded test probes Ø 4 mm
 - 300 V CAT II > P01295459Z

Kit with 2 PVC leads
 + 2 test probes Ø4 mm - Straight male plug
 Ø4 mm - Elbowed male plug Ø4 mm
 - Test probe Ø 4 mm - Female plug Ø 4 mm
 - CAT II 300V > P01295475Z

Set of 2 red/black magnetized test probes
 For voltage measurement only, test probe Ø
 6.6 mm - Elbowed female plug Ø 4 mm
 - 1,000 V CAT III / 600 V CAT IV
 > P01103058Z

Set of 2 red/black crocodile wire grips
 20 A - 1,000 V CAT III > P01102053Z

Set of 2 adapters - Insulated female BNC plug -
 Insulated red/black male plugs Ø 4 mm with
 19 mm spacing - 600 V CAT III
 > P01102101Z

Kit of 2 PVC leads + 2 test probes
 Ø 2 mm - Straight male plug Ø 4 mm - Elbowed
 male plug Ø 4 mm - Test probe Ø 2 mm - Female
 plug Ø 4 mm - 300 V CAT II > P01295474Z

PVC lead
 Insulated male BNC plug - Insulated straight male
 banana plugs Ø 4 mm (red/black) with rear
 connection - 1 m - 500 V CAT III > AG-1066Z

Other accessories



SET OF 2 INSULATION-PIERCING CLIPS (R/B) 30 V_{AC}, 60 V_{DC}
> P01102055Z



Current lead equipped with a French 2P+E power socket
For inserting an ammeter in series and in total safety to measure current with a current clamp without removing the external sheath of the power supply cable
> P03295509



Measurement lead for French and German 2P+E power sockets
For direct measurement on a mains socket
Quick implementation and reliable connections
> P06239307



Set of 2 adapters
Male BNC - insulated female sockets (R/B) Ø 4 mm with 19 mm spacing - 500 V CAT I, 150 V CAT III
> P01101846



External charger module + 4 x AA Ni-MH batteries
> HX0053



Set of 2 adapters
Male BNC - Insulated male sockets (R/B) Ø 4 mm with 19 mm spacing
500 V CAT I, 150 V CAT III
> P01101847



CMS clamp
Copper-Gold-plated Beryllium contacts - Output via male plugs Ø 4 mm - Length 1.20 m - SELV
> HX0064



SHT40KV
High-voltage probe for multimeters
Max. rated voltage: 40kVDC, 28 kV_{rms} or 40 kV_{peak}
Division ratio (input/output): 1 kV/1 V
> P01102097



C.A 753
Measurement adapter for European 2P+E and Schuko sockets
- Suitable for measurements on P (Phase), N•(Neutral) and PE (Earth) conductors in total safety
- Guarantees mechanical and electrical contact with all test probes (Ø2, Ø4, IP2X, etc.)
- Shows the presence of a P-N voltage (> 200 V) and indicates the position of the phase

Temperature measurement

Adapters



Set of 2 thermocouple safety adapters for multimeters
Female thermocouple plug - Insulated male plugs (R/B) Ø 4 mm with 19 mm spacing
> P01102106Z



Pt100/Pt1,000 probe adapter for multimeters
Female Pt100/Pt1,000 plug - Insulated male plugs (R/B) Ø 4 mm
> HX0091



Safety adapter and K-sensor temperature probe
- For multimeters and clamp multimeters equipped with a temperature measurement calibre with banana inputs with 19 mm spacing
- Measurement range from -50 °C to +350 °C
> P01102107Z

Physical measurement K thermocouple sensors

Thermocouple technology

The sensor is formed by the thermocouple measurement junction at its hot point. The reading is taken at its cold junction, which requires compensation to simulate the point at 0 °C.

Various materials are used to manufacture these thermocouples.

The thermo-electric forces and tolerances are defined in the IEC 584 standard.

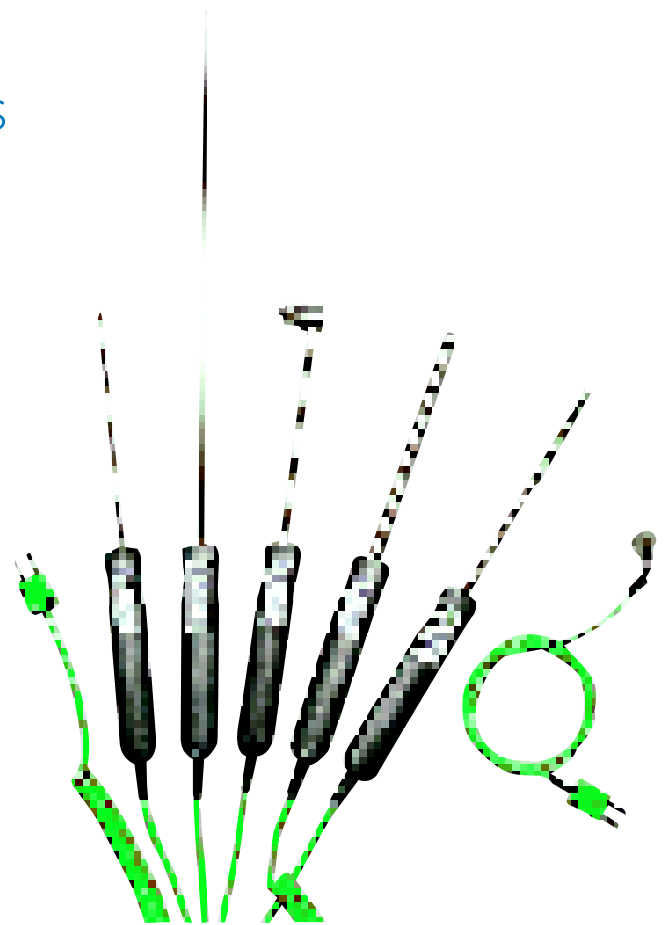

IEC 584 correspondence table (extracts): temperature and voltage

°C	mV	°C	mV	°C	mV
EIT 584		EIT 584		EIT 584	
-40	1.527	50	2.023	600	24.905
0	0	100	4.096	1,000	41.276
	200	8.138	1,200	48.838	

Interchangeability tolerance according to NF EN 60584-2

Class 1	Class 2
-40 °C to +375 °C: ±1.5 °C	-40 °C to +333 °C: ±2.5 °C
+375 °C to +1,000 °C: ±0.004 x t °C	+333 °C to +1,200 °C: ±0.0075 x t °C

where *t* is the temperature in °C

Model	Measurement range	Response time	Diameter	Length	Description
K thermocouple sensors					
SK1 needle	-50 to +800 °C	1 s	3 mm	15 cm	For penetration into pasty, viscous products
SK2 bendable	-50 to +1,000 °C	2 s	2 mm	1 m	Can be bent as required
SK3 semi-rigid	-50 to +1,000 °C	6 s	4 mm	50 cm	Can be bent slightly
SK4 surface	0 to +250 °C	1 s	5 mm	15 cm	Adapted for measurements on small surfaces
SK5 surface	-50 to +500 °C	1 s	5 mm	15 cm	8 mm Ø spring tip ensuring optimum contact even if the sensor is not placed at right angles
SK6 flexible	-50 to +285 °C	1 s by contact 3 s in ambient air	1 mm	1 m	Recommended for points where access is difficult
SK7 air	-50 to +250 °C	5 s	5 mm	15 cm	For measurements of ambient air. Thermocouple protected by a metal sheath Ø 8.5 mm
SK8 auto-grip	-50 to +140 °C	10 s on stainless steel pipe (Ø 12 mm)	10 mm ≤ Ø ≤ 90 mm		The thermocouple placed on a sheet of copper, at the end of a double sided Velcro ribbon, is held in contact by winding the ribbon round the pipe
SK11 needle	-50 to +600 °C	12 s	3 mm	13 cm	For penetration into pasty, viscous products
SK13 general use	-50 to +1,100 °C	12 s	3 mm	30 cm	All uses
SK14 surface-elbowed	-50 to +450 °C	8 s	6 mm	13 cm	Surface temperature for difficult access. Tip Ø 15 x 30 mm
SK15 surface	-50 to +900 °C	2 s	8 mm	13 cm	Tip Ø 8 mm with spring, ensuring optimum contact
SK17 air	-50 to +600 °C	3 s	6 mm	13 cm	For ambient air measurements
SK19 surface with magnet	-50 to +200 °C	7 s	14 mm	12 mm	Fixed by magnet

References to order

P03652901 : SK 1
P03652902 : SK 2
P03652903 : SK 3
P03652904 : SK 4
P03652905 : SK 5
P03652906 : SK 6

P03652907 : SK 7
P03652908 : SK 8
P03652917 : SK 11
P03652918 : SK 13
P03652919 : SK 14
P03652920 : SK 15

P03652921 : SK 17
P03652922 : SK 19
P03652909 : CK 1
P03652910 : CK 2
P03652913 : CK 3
P03652914 : CK 4

Pt100 platinum probes

Pt100 Ω technology

The relation between the resistance and the temperature, like the tolerances, is defined in the IEC 751 European standards.

2 different technologies are used:

- platinum-wire resistors wound around an insulating support
- ceramic substrate coated with a platinum film

IEC 751 correspondence table (extracts): temperature and resistance

$^{\circ}\text{C}$ EIT 90	Ω	$^{\circ}\text{C}$ EIT 90	Ω	$^{\circ}\text{C}$ EIT 90	Ω
200	18.52	50	119.4	400	247.09
-100	60.26	100	138.51	600	313.71
0	100	200	175.40	850	390.48

Tolerance class - The IEC 751 standard defines the interchangeability tolerances as follows:

Tolerance class	Tolerance
A	$0.15 + 0.0025 \times [t]$
B	$0.3 + 0.005 \times [t]$

[t] is the absolute value of the temperature in $^{\circ}\text{C}$



SP 14



Model	Measurement	Response	Diameter	Length	Tolerance class	Description
Pt100 platinum probes						
SP 10	-50 to +200 $^{\circ}\text{C}$	6 s	5 mm	Needle 13 cm	B	For flat surfaces. The spring ensures optimum contact, even if the sensor is not set up perpendicularly.
SP 11	-100 to +600 $^{\circ}\text{C}$	7 s	3 mm	Needle 13 cm	B	For penetration (20 mm minimum) in pasty and viscous products.
SP 12	-100 to +600 $^{\circ}\text{C}$	5 s	5 mm	Needle 13 cm	B	Suitable for all ambient air measurements (moving air). If the air is "stationary", agitate the sensor.
SP 13	-100 to +600 $^{\circ}\text{C}$	7 s	3 mm	Needle 13 cm	B	Specially designed for liquids
SP 14	-40 to 450 $^{\circ}\text{C}$	7 s	3 mm	20 cm	A	Sensor in stainless-steel 316L sheath for general use

References to order

P03652712: SP 10
P03652713: SP 11

P03652714: SP 12
P03652715: SP 13

HX0091: Banana plug / Pt100 connector adapter

General-purpose transport and protection accessories



MC 0160B



MC 0160B
+ MC 0159B



AE 0237



HX0052

For MX Concept series: MX 21, MX 22, MX23, MX 24, MX 24B	
Sheath	AE0237
Soft case	AE0190
Hard case	HX0009
Transport soft case	HX0018
For ASYC II series: MX 20, MX 44, MX 5x	
Sheath	MC0160B
Handle	MC0159B
Hard case	AE0227
Soft case	AE0193
For MTX series: MTX 3281, MTX 3282, MTX 3283	
Soft case	HX0052
For analogue multimeters	
Soft case	AE0216
Hard case	AE0228
For ASYC IV multimeters	
Soft case: MTX 3290 and MTX 3291	HX0052 B
Soft case: MTX 3292 and MTX 3293	HX0052C



MTX329X bag



MultiFix accessory for DMMs

When used with compatible measuring instruments, soft cases, bags, etc., the MultiFix accessory can be used to transport and mount products so that they are more comfortable to use.



P01102100Z

Metal cases

Equipped with foam inserts and delivered with strap and keys



P01298072



P01298004



P01298071

All-terrain waterproof site cases

Equipped with foam inserts



P01298068



P01298069

Dimensions	References
270 x 195 x 65 mm	P01298071
320 x 255 x 75 mm	P01298004
440 x 310 x 135 mm	P01298072

Dimensions	References
272 x 248 x 130 mm	P01298068
272 x 248 x 182 mm	P01298069

Choosing your voltage probe



There are multiple criteria for choosing a probe. The approach below helps to specify your requirements and guide you naturally towards the most suitable model for your application.

To choose the probe to adapt to your oscilloscope, we advise you to follow the logic below:

Measurement input

- Max. AC voltage measurement and choice of installation category: CAT II or III? Attenuating probe or differential probe?
- Choice of attenuation: 1/10, 1/100 or 1/1,000 or 1/20, 1/200? Bandwidth according to the oscilloscope?
- Measurement input impedance

Output- Connection technology

- BNC or PROBIX?

Specific features

- What are the other criteria? Capacitance, rise time, safety, power supply, etc.



Specifications	Voltage probes				
CAT II voltage probes	•				
High-voltage probe		•			
CAT II 300 V voltage probes			•		
PROBIX probes for SCOPIX				•	
Differential probes					•
Pages	108	109	109	73	110-111

Choosing your current probe for oscilloscopes

Current probes				
Measurement with AC/DC clamp	•			
Measurement with AC clamp		•		
Measurement with flexible AC clamp			•	
Pages	112	112	113	
Connection and protection accessories				
BNC	•			
Protection and transport		•		
Fuses			•	
Pages	114	115	116	
Software	Scopix-Handscope		DOX	
Pages	76-77		64	

Electronic voltage probes

HX0003, HX0004, HX0005, HX0006 & HX0108

- A family of 5 products to cover all types of requirements
- Attenuation ratio of 10 or 100 (depending on the model)
- Bandwidth from 150 MHz to 300 MHz
- EN61010 safety from 400 V CAT II to 1,000 V CAT III (depending on the model)
- Compensation range from 12 to 22 pF or from 12 to 25 pF (depending on the model)
- Connection accessories are available for the probes:
 - HX0007: hook-type wire-grip termination
 - HX0008: crocodile-type wire-grip termination
- Additional accessories are delivered with the HANDSCOPE HX0108 kit
 - ISOPROBE III probe compliant with 600 V CAT III with 1/10 attenuation on a 500 MHz bandwidth
 - + HX0107 BNC /BAN adapter



Specifications	HX0003	HX0004	HX0005	HX0006	HX0108
Attenuation	1:10	1:10	1:10	1:100	1:10
Bandwidth	150	250	450	300	500
Input impedance (MΩ)	10 ±1 %	10 ±1 %	10 ±1 %	100 ±1 %	10 ±1 %
Capacitance (pF)	14	14	< 14	≤ 6	12
Rise time (ns)	1.2	≤ 1.2	≤ 1	< 1	0.9
EN61010-2-031 safety	400 V CAT II	1,000 V CAT II	1,000 V CAT II	1,000 V CAT II max 5 kV peak	600 V CAT III
Compensation range (pF)	12 to 25	12 to 25	12 to 25	12 to 22	10 to 22
Retractable safety sleeve	Grey	Blue	Violet	Red	Grey

Standard state at delivery

HXxxxx: 1 probe, 1 reference lead, 1 user manual

Accessories for HX000x

HX0007: Hook-type wire-grip termination
HX0008: Crocodile wire-grip termination

References to order

HX0003: Compact 10:1 probe, 150 MHz
HX0004: Compact 10:1 probe, 250 MHz
HX0005: Compact 10:1 probe, 450 MHz
HX0006: Compact 100:1 probe, 300 MHz
HX0108: Measurement kit comprising 1 compact 10:1 probe - 500 MHz 600 V CAT III, and one BNC/Banana ø 4 mm adapter (HX0107)



HX0108 kit

High-voltage / high-frequency probe

HX0027

- Design mounted on a patented ceramic support, with the elements adjusted by laser
- Interchangeable spring-mounted tip
- 1/1,000 probe with 30 MHz bandwidth
- This 14kV high-voltage probe can be used in various sectors:
 - automotive inrush
 - radar pulse measurement
 - motor control
 - transformers
 - switching systems in electrical engineering and power electronics
 - pulsed discharge lighting equipment (Xenon lamps)
 - drilling systems in the oil industry
 - railway sector



General-purpose probes

HX0206, HX0210 & HX0220

- A family of 3 products for general-purpose requirements
- Attenuation with a switchable ratio of 1:1 or 10:1
- 60 MHz, 100 MHz or 200 MHz depending on the model



Specifications	HX0027	HX0206		HX0210		HX0220	
Attenuation	1:1,000	1:1	1:10	1:1	1:10	1:1	1:10
Bandwidth	30	15	60	15	100	15	200
Input impedance (MW)	100+-1 %	1	10	1	10	1	10
Capacitance (pF)	< 2.5	45	15	46	15	45	11
Rise time (ns)	< 12	23	6	23	3.5	35	1.7
EN61010-2-031 safety	14 kV max 40 kV peak	300 V CAT II	300 V CAT II	300 V CAT II	300 V CAT II	300 V CAT II	300 V CAT II
Compensation range (pF)	10 to 50	-	10 to 50	-	10 to 50	-	10 to 35

Standard state at delivery

HX0027: 1 probe, 1 "hook" measurement termination, 1 crocodile clip, 1 screwdriver for adjustment, 1 user manual, 1 hard case
 HX0206-HX0210-HX0220: 1 probe, 1 "hook" measurement termination, 1 crocodile measurement earth, 1 screwdriver for adjustment, 1 user manual

Differential voltage probes

MX 9030, MTX1032-B & MTX1032-C

Ideal accessories for analogue or digital oscilloscopes for viewing signals not referenced to the earth, the MTX 1032-B and MTX 1032-C are equipped with 2 differential channels.

Powered by the mains supply, these probes can be used separately or hooked up to MTX Compact oscilloscopes. The MX 9030 probe is supplied in a stand-alone hand-

- A family of 3 products to meet the various requirements
- 1 or 2 input channels, 30 MHz or 50 MHz bandwidth
- Extra-long banana or coaxial/banana measurement leads
- Supplied in a laboratory casing or handheld casing with wrist-strap



Use of differential probes with a Class 1 oscilloscope protected by the earth

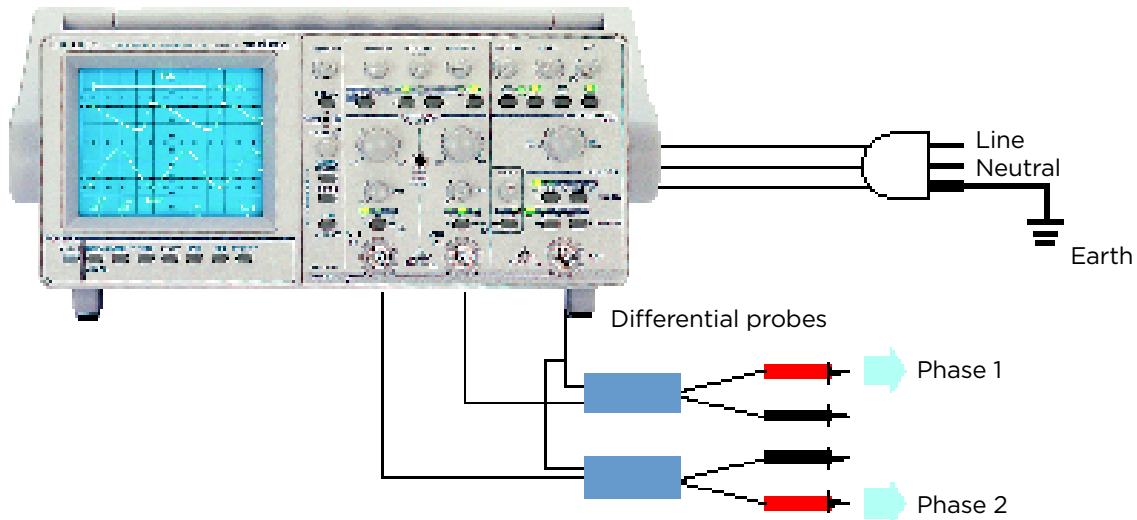

Specifications	MX 9030-Z	MTX 1032-B	MTX 1032-C
Diff. input voltage	±60 V or ±600 V	±40 V or ±400 V	
Max. Voltage in common mode	±600 V		
Attenuation / Accuracy	1/20 and 1/200 - ±3 %	1/10 and 1/100 - ±3 %	
Bandwidth	30 MHz	30 MHz	50 MHz
Rise time	11.7 ns	11.7 ns	7 ns
Output impedance	50 Ω		
Coaxial output voltage (max.)	± 3 V with 1 MΩ load	± 4 V with 1 MΩ load	
Noise level	< 10 mVpp		
General specifications			
Power supply	9 V battery	Mains: 230 V _{AC} ±10 % 50/60 Hz	
Safety	IEC 61010-1 600 V CAT IV	IEC 61010-1 600 V CAT III	IEC 61010-1 600 V CAT II
Dimensions / Weight	163 x 62 x 40 mm / 195 g (with battery)	270 x 250 x 63 mm / 1.2 kg	

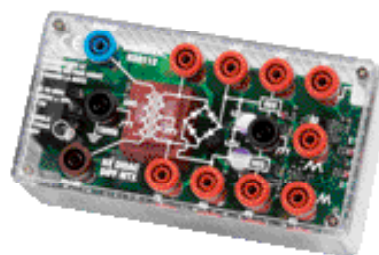

MTX 112U:
built-in double differential probe

Standard state at delivery

MX9030-Z: 1 single-channel probe with output on BNC cable, 1 standard battery installed, 1 set of PVC banana leads 1.10 m long, 1 set of 2 industrial-grade crocodile clips, 1 user manual

MTX1032-B: 1 x 2-channel probe in "MTX Pack" casing, 2 BNC cables 20 cm long, 2 sets of PVC banana leads 1.10 m long, 1 European mains power cable, 1 set of accessories for mounting the probe on the oscilloscope, 1 user manual

MTX1032-C: 1 x 2-channel probe in "MTX Pack" casing, 2 BNC cables 20 cm long, 1 set of 2 BNC-banana cables 2 m long, 2 crocodile wire-grips for probes, 1 European mains power cable, 1 set of accessories for mounting the probe on the oscilloscope, 1 user manual

References to order

MX9030-Z: 1 x 30 MHz stand-alone differential probe
 MTX1032-B: 2 x 30 MHz differential probe with banana inputs
 MTX1032-BRK: MTX1032-B rack version
 MTX1032-C: 2 x 50 MHz differential; probe with coaxial inputs
 MTX1032-CRK: MTX1032-C rack version

Available accessories

See pages 107 to 115



For further details...

Insulated current probes AC/DC current probes

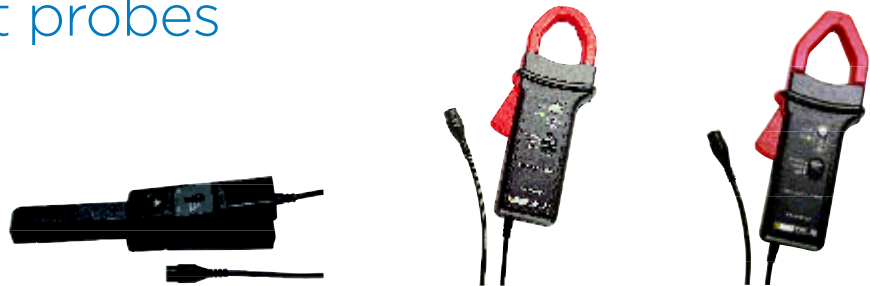

Specifications	HX0102	E3N	PAC12	PAC22
Measurement range	3 mA to 20 A _{AC/DC}	50 mA to 100 A _{AC/DC}	200 mA to 600 A _{AC/DC}	200 mA to 1,400 A _{AC/DC}
Transformation ratio	100 mV/A	100 mV/A - 10 mV/A	10 mV/A - 1 mV/A	10 mV/A - 1 mV/A
Bandwidth	DC to 60 kHz	DC to 100 kHz	DC to 10 kHz	DC to 10 kHz
Accuracy	< 1.5 %	< 3 %	< 1.5 %	≤ 1.5 % and ≤ 2 %
RMS analogue output	30 mA to 20 A _{AC/DC} 100 mV _{DC} /A	-	-	-
Clamping diameter	11.8 mm	11.8 mm	30 mm	42 mm
Output connector	BNC	BNC	BNC	BNC
Cable length	2 m	2 m	2 m	2 m
Dimensions	231 x 67 x 36 mm	231 x 67 x 36 mm	224 x 97 x 44 mm	236.5 x 97 x 44 mm
Weight	330 g	330 g	440 g	520 g
Power supply	1 x 9 V	1 x 9 V	1 x 9 V	1 x 9 V
Safety	CEI 61010-2-032 - 300 V CAT IV / 600 V CAT III			
Accessories supplied	1 x 9 V battery and user manual			
To order	HX0102 HX0102-K*	P01120043A P01120047*	P01120072	P01120073

AC current probes



Specifications	MN 60	Y7N	C160	D38N
Measurement range	0.1 to 60 A peak AC and 0.5 to 600 A peak AC	1 A to 1,200 A peak	0.1 to 2,000 A peak	1 A to 5,000 A peak
Transformation ratio	100 mV - 10 mV/A	1 mV / A	100 mV/A - 10 mV/A - 1 mV/A	10 mV/A - 1 mV/A - 0.1 mV/A
Bandwidth	40 Hz to 40 kHz	5 Hz to 10 kHz	10 Hz to 100 kHz	30 Hz to 50 kHz
Accuracy	≤ 2 % and ≤ 1.5 %	≤ 2 %	≤ 3 %, ≤ 2 %, ≤ 1 %	≤ 2 %
Clamping diameter	20 mm	30 mm	52 mm	64 mm
Output connector	BNC	BNC	BNC	BNC
Cable length	2 m	2 m	2 m	2 m
Dimensions	135 x 51 x 30 mm	195 x 66 x 34 mm	216 x 111 x 45 mm	305 x 120 x 48 mm
Weight	180 g	420 g	550 g	1,200 g
IEC 61010-2-32 safety	300 V CAT IV / 600 V CAT III			
Accessories supplied	1 user manual			
To order	P01120409	P01120075	P01120308	P01120057A

Flexible current probes

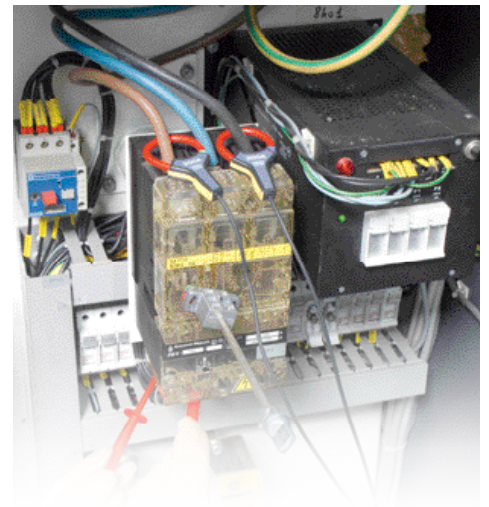

Specifications	MA200 30-300/3 – (17 cm)	MA200 30-300/3 – (25 cm)	MA200 3000/3 – (35 cm)
Measurement range	0.5 to 45 Apeak 0.5 to 450 Apeak	0.5 to 45 Apeak 0.5 to 450 Apeak	5 A to 4,500 Apeak
Transformation ratio	100 mV/A - 10 mV/A	100 mV/A - 10 mV/A	1 mV/A
Bandwidth	5 Hz to 1 MHz	5 Hz to 1 MHz	5 Hz to 1 MHz
Accuracy	≤ 1% +0.3 A	≤ 1% +0.3 A	≤ 1% +0.3 A
Clamping diameter	45 mm	70 mm	100 mm
Output connector	BNC	BNC	BNC
Cable length	2 m + 40 cm	2 m + 40 cm	2 m + 40 cm
Dimensions	140 x 64 x 28 mm	140 x 64 x 28 mm	140 x 64 x 28 mm
Weight	200 g	200 g	200 g
Power supply	1 x 9 V	1 x 9 V	1 x 9 V
IEC 61010-2-32 safety	600 V CAT IV 1,000 V CAT III	600 V CAT IV 1,000 V CAT III	600 V CAT IV 1,000 V CAT III
Accessories supplied	1 x 9 V battery and 1 user manual		
To order	P01120570	P01120571	P01120572

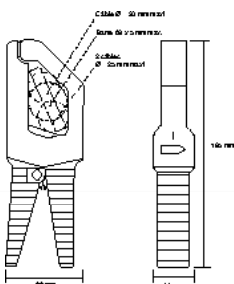

Y7N clamp

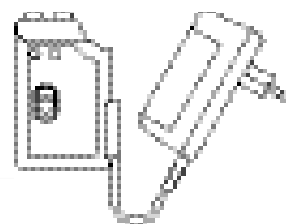

Optional accessory

Mains adapter for MA200: P01102087



For further details...

ACCESSORIES

Coaxial cables

Coaxial cables



Safety leads with 50 Ω impedance, length 1 m- IEC 61010-2-031 Cat. III 500 V, black:
insulated male BNC / banana plugs with rear connection

> AG1066-Z (2 p)



Safety leads with 50 Ω impedance,
length 1 m IEC61010-2-031 - 600 V CAT III, black

> HX0106 (2 p)



Earth safety leads, length 2 m, Ø 4 mm banana connection
- IEC 61010-2-031 Cat. III 1,000 V:
Female banana plug / female, yellow/green (earth)

> P01295073A (5 p)

Accessories



Set of 2 adapters
Insulated male BNC plug - insulated female plugs (R/B) Ø 4 mm with 19 mm spacing
600 V CAT III

> HX0107



Set of 2 adapters
Insulated female BNC - Insulated plugs (RIN) Ø 4 mm with 19 mm spacing - 600 V CAT III

> P01102101Z



Set of 2 adapters
Male BNC -insulated female sockets (R/B) Ø 4 mm with 19 mm spacing
500 V CAT I, 150 V CAT III

> P01101846



Set of 2 adapters
Male BNC - insulated male sockets (R/B) Ø 4 mm with 19 mm spacing
500 V CAT I, 150 V CAT III

> P01101847



Load adapter
50 Ω BNC additional load

> PA4119-50 (1 p)



Rack for safety leads (1 rack)
Rack for hanging 60 leads

> P01101914 (1 p)

Insulated T-joint IEC 61010-2-031 - 500 V CAT I
1 insulated male BNC / 2 female BNC

> HA2004-Z (3 p)



Insulated extension IEC 61010-2-031 - 500 V CAT I
Female BNC / female BNC

> HA2005 (1 p)



Safety coupling jumper with 19 mm spacing - Ø 4 mm - 36 A
- IEC 61010-2-031:
Set of 10 black coupling jumpers

> P01101892A

Protection and transport accessories and mechanical adaptations

For oscilloscopes



MTX-family bag for MTX 3240, MTX 3250, MTX 3252, MTX 3352 and MTX 3354 models. The mouse can be stored in the side pocket.

> HX0024



Empty hard case for Scopix equipped with pre-cut foam inserts for stowing documents and accessories (power supply, Probox accessories, communication cables, etc.).

> HX0038



Protective hands-free bag for HANDSCOPE portable oscilloscopes (OX5022 and OX5042).

> HX0105



Second battery kit for SCOPIX III

> HX0063



Charger unit for 12 V_{DC} vehicle cigarette lighter

> HX0061

Fuse selection table

Product concerned	Standardized dimensions	Amperage	Sales reference
AX 501	5 x 20	3.15 A	AT0069
AX 502	5 x 20	3.15 A	AT0069
AX 503	5 x 20	3.15 A	AT0069
MTX 3240	5 x 20	0.315 A	P01297074
MTX 3250	6 x 32	10 A	AT0095
MTX 3281	10 x 38	11 A	P01297092
MTX 3282, MTX 3292	10 x 38	11 A	P01297092
MTX 3283, MTX 3293	10 x 38	11 A	P01297092
MX 1	6 x 32	10 A	AT0070
MX 1	6 x 32	1.6 A	AT0071
MX 2B	6 x 32	10 A	AT0070
MX 2B	6 x 32	1.6 A	AT0071
MX 20	8 x 32	10 A	AT0055
MX 20	5 x 20	0.63 A	AT0094
MX 20HD	6 x 32	10 A	AT0095
MX 20HD	5 x 20	0.63 A	AT0094
MX 22	6 x 32	10 A	AT0095
MX 22	6 x 32	0.63 A	AT0519
MX 23	6 x 32	10 A	AT0095
MX 24B	6 x 32	10 A	AT0095
MX 24B	6 x 32	0.63 A	AT0519
MX 35D	6 x 32	10 A	AT0070
MX 35D	5 x 20	3.15 A	AT0053
MX 430	10 x 38	10 A	P01100731
MX 430	5 x 20	0.16 A	P03297508
MX 44	6 x 32	10 A	AT0095
MX 44	5 x 22	0.63 A	AT0518
MX 44HD	6 x 32	10 A	AT0095
MX 44HD	5 x 20	0.63 A	AT0518
MX 51	8 x 32	10 A	AT0055
MX 51	5 x 20	0.63 A	AT0094
MX 52	8 x 32	10 A	AT0055
MX 52	5 x 20	0.63 A	AT0094
MX 53	6 x 32	10 A	AT0095
MX 53	5 x 20	0.63 A	AT0518
MX 54C	6 x 32	10 A	AT0095
MX 54C	5 x 20	0.63 A	AT0518
MX 553, MX 5006	6 x 32	10 A	AT0095
MX 556, MX 5060	6 x 32	10 A	AT0095
MX 55C	6 x 32	10 A	AT0095
MX 55C	5 x 20	0.63 A	AT0518
MX 56C	6 x 32	10 A	AT0095
MX 56C	5 x 20	0.63 A	AT0518
MX 573	5 x 20	2 A	AA0921
MX 573	10 x 38	10 A	P01100731
MX 57EX		1 A	AT0064
MX 57EX		0.5 A	AT0057
MX 58HD	10 x 38	11 A	P01297092
MX 58HD	5 x 20	0.63 A	AT0518
MX 59HD	10 x 38	11 A	P01297092
MX 59HD	5 x 20	0.63 A	AT0518
OX 530	5 x 20	2.5 A	AT0090
OX 803B	5 x 20	2.5 A	AT0090
OX 832	5 x 20	0.315 A	P01297074
OX 836B	5 x 20	2.5 A	AT0090

Product	Description	Page
A		
A110	Flexible AC current sensor	99
A130	Flexible AC current sensor	99
AmpFLEX®	Flexible AC current sensor	29
AX 1360-P	Laboratory power supply	90 - 92
AX 501	Laboratory power supply	90 - 91
AX 502	Laboratory power supply	90 - 91
AX 503	Laboratory power supply	90 - 91
B		
B102	Leakage current clamp	101
C		
C100	AC current clamp	98
C103	AC current clamp	98
C106	AC current clamp	29 - 98
C107	AC current clamp	29 - 98
C160	AC current probe	112
C173	Leakage current clamp	101
CX 1651	Multi-function calibrator	94 - 95
D		
D38N	AC current probe	112
DOX 2025	Laboratory digital oscilloscope	57 - 60 - 61
DOX 2040	Laboratory digital oscilloscope	57 - 60 - 61
DOX 2100	Laboratory digital oscilloscope	57 - 60 - 61
DOX 3104	Laboratory digital oscilloscope	57 - 62 - 63 - 85
DOX 3304	Laboratory digital oscilloscope	57 - 62 - 63 - 85
E		
E3N	Insulated AC/DC current probe	112
E6N	AC/DC current clamp	28 - 29 - 100
G		
GX 1025	Arbitrary function generator	85 - 88 - 89
GX 1050	Arbitrary function generator	85 - 88 - 89
GX 305	Low-frequency generator	85 to 87
GX 310	Low-frequency generator	85 to 87
GX 320	Low-frequency generator	85 to 87
H		
HX 0059	Software for multimeters	33
HX0003	Electronic voltage probe	108
HX0004	Electronic voltage probe	108
HX0005	Electronic voltage probe	108
HX0006	Electronic voltage probe	108
HX0027	High-voltage - high-frequency probe	109
HX0082	Near-field probe	82
HX0083	Near-field probe	82
HX0102	Insulated AC/DC	112
HX0108	Electronic voltage probe	108
HX0206	General-purpose probe	109
HX0210	General-purpose probe	109
HX0220	General-purpose probe	109
K		
K1	Process current clamp	101
K2	AC/DC current clamp	28 - 29 - 100
M		
MA110	Flexible AC current clamp	99
MA130	Flexible AC current clamp	99
MA200	Flexible current clamp	115
MINI01	AC current clamp	98
MINI02	AC current clamp	28 - 29 - 98
MINI03	Current clamp	28
MINI04	Current clamp	28
MINI05	AC current clamp	28 - 29 - 98
MINI06	Current clamp	28
MINI07	Current clamp	28
MINI08	Current clamp	28
MINI09	Current clamp	28
MiniFLEX®	Flexible current clamp	29
MN08	AC current clamp	29 - 98
MN09	AC current clamp	29 - 98
MN12	AC current clamp	98
MN14	Current clamp	98
MN60	AC current probe	112

Product	Description	Page
MN71	Current clamp	28 - 29
MN73	Leakage current clamp	28 - 29 - 101
MN89	AC current clamp	29 - 98
MTX 1050	Spectrum analyser	80 to 82
MTX 1052	Screenless digital oscilloscope	49 to 51 - 54 - 55
MTX 1054	Screenless digital oscilloscope	49 to 51 - 54 - 55
MTX 112	Screenless digital oscilloscope	49 - 51 - 53
MTX 162	Screenless digital oscilloscope	49 - 51 - 52
MTX 202	On-site digital multimeter	15 - 16 - 17
MTX 203	On-site digital multimeter	15 - 16 - 17
MTX 3290	ASYC IV digital multimeter	15 - 22 to 25
MTX 3291	ASYC IV digital multimeter	15 - 22 to 25
MTX 3292	ASYC IV digital multimeter	15 - 22 - 23 - 26 - 27
MTX 3293	ASYC IV digital multimeter	15 - 22 - 23 - 26 - 27
MTX1032-B	Differential voltage probe	110
MTX1032-C	Differential voltage probe	110
MX 1	On-site analogue multimeter	8 & 13
MX 125	Voltmeter	45
MX 135	Ammeter	45
MX 24	On-site digital multimeter	15 - 18 - 19
MX 24B	On-site digital multimeter	15 - 18 - 19
MX 2B	On-site digital multimeter	8 & 13
MX 350	Clamp multimeter	35 - 36
MX 355	Clamp multimeter	35 - 36
MX 406B	Analogue insulation tester	42
MX 407	Insulation tester	43
MX 435D	Multi-function installation tester	44
MX 5006	Benchtop multimeter	15 - 30 - 31
MX 5060	Benchtop multimeter	15 - 30 - 31
MX 57Ex	Multimeter for difficult environments	15 - 20 - 21
MX 57EX-CAL	Software for multimeters	33
MX 604	Insulation tester	42
MX 650	Clamp multimeter	35 - 37
MX 655	Clamp multimeter	35 - 37
MX 670	Clamp multimeter	35 - 38
MX 675	Clamp multimeter	35 - 38
MX 9030	Differential voltage probe	110
MX 98	Cos-phi meter	40
O		
OX 5022	On-site digital oscilloscope	65 to 67
OX 5042	On-site digital oscilloscope	65 to 67
OX 530	Analogue oscilloscope	49 - 56
OX 6062B	Laboratory digital oscilloscope	57 to 59
OX 6202B	Laboratory digital oscilloscope	57 to 59
OX 7042	On-site digital oscilloscope	65 - 68 - 69 - 70
OX 7062	On-site digital oscilloscope	65 - 68 - 69 - 71
OX 71	Oscilloscope analogique	49 - 56
OX 7102	On-site digital oscilloscope	65 - 68 - 69 - 71
OX 7104	On-site digital oscilloscope	65 - 68 - 69 - 70 - 71
OX 7202	On-site digital oscilloscope	65 - 68 - 69 - 71
OX 7202-BUS	Bus analyser oscilloscope	72
OX 7204	On-site digital oscilloscope	65 - 68 - 69 - 71
OX 7204-BUS	Bus analyser oscilloscope	72
OX 803B	Analogue oscilloscope	49 - 56
Oxi 6204	Laboratory digital oscilloscope	57 to 59
P		
PAC11	Current clamp	28 - 29
PAC12	Insulated AC/DC current probe	112
PAC20	Current clamp	28 - 29
PAC22	Insulated AC/DC current probe	112
PROBIX	Accessories for SCOPIX oscilloscopes	73 - 74
Pt100	Platinum probe	105
PX 110	Wattmeter	39
PX 120	Wattmeter	39
S		
SCOPENET	Software for oscilloscopes	77
SK	K-thermocouple sensors	104
SX METRO	Software for oscilloscopes	76
SX-ASYC2C/B	Software for multimeters	33
SX-DMM	Software for multimeters	32
T		
TCX 01	SMD / Surface Mounted Device tester	8 & 9
TX 01	LED voltage tester	8 & 12
V		
VIRTUAL PRINTER	Software for oscilloscopes	76
VX 0003	LF electric field tester	8 - 10 - 11
VX 0100	LF electric field tester	8 - 10 - 11
Y		
Y7N	AC current probe	112

Product	Page
A	
AC current clamp	98
AC current probes	112
AC/DC current clamps	100
AC/DC current probes	112
Accessories for multimeters	97 to 107
Accessories for oscilloscopes	107 to 116
Acquisition software	32 to 34
Analogue ammeter	40
Analogue multimeter	8, 13
Analogue oscilloscope	46 - 56
Analogue voltmeter	40
Arbitrary function generators	84, 85, 88, 89
C	
Coaxial accessories	114
Component testers	8, 9
D	
DDS function generators	84 to 89
Didascope training oscilloscope	48 to 53
Differential voltage probes	110, 111
Digital oscilloscope	47 to 55 - 57 to 75
E	
Earth (3P)	41 to 45
Earth loop	41 to 45
Electric field tester	8, 10, 11
F	
Field bus oscilloscope	72
Field bus	72
Flexible probes for AC current	99
Fuses	116
G	
General-purpose probe	109
Graphical digital multimeter	14, 15, 26, 27
H	
High-voltage / high-frequency probe	109
I	
Insulation tester	41 to 43
Insulation	41 to 43
K	
K thermocouple	104
L	
Laboratory multimeter	15, 30, 31
Laboratory oscilloscope	60 to 63
Leads	102, 103
Leakage current clamp	101
Lighting-arrester tester	42

Product	Page
M	
Metrology software	33
MTX family bag	106
Multi-function calibrator	94, 95
Multi-function installation tester	44
Multi-function oscilloscope	65 to 72
Clamp multimeter	35 to 38
Multimeter for difficult environments	15, 20, 21
N	
Near-field probe	82
O	
On-site digital multimeter	14 to 26
On-site oscilloscope	65 to 75
P	
PROBIX system	73, 74
Process current clamp	101
Programmable power supply	90, 92
Pt 100	105
R	
RCD testing	41 to 43
S	
SCOPIX bag	115
SCOPIX equipped case	115
Screenless oscilloscope	49 to 55
Shunt	93
Software for oscilloscopes	76, 77
Spectrum analyser	78 to 82
T	
Testing and electrical safety	41 to 44
Training box	93
Training oscilloscope	49 to 53
Transport accessories	106, 115
V	
Variable power supplies	90, 91
Voltage probes	107 to 111
Voltage tester	8, 12
W	
Wattmeter	39

Reference	Page	Reference	Page	Reference	Page
A					
AE0193	106	HX0073	73	OX7204-BUS	71
AE0216	106	HX0077	75	OX0530	56
AE0227	106	HX0082	81	OX0530-S	56
AE0228	106	HX0083	81	OX0803B	56
AE0237	106	HX0091	103	OX0830BS	56
AG1066-Z	102	HX0092	103	OX5022-C	67
AX0501A	91	HX0093	74	OX5022-CK	67
AX0502A	91	HX0094	73	OX5042-C	67
AX0503A	91	HX0095	74	OX5042-CK	67
AX1360-P	92	HX0096	73	OX6062B-CFG	59
C					
CX1651	94	HX0102	67	OX6062B-CSD	59
D					
DOX2025	60	HX0106	87	OX6062B-CSDO	59
DOX2040	60	HX0107	87	OX6062B-MSD	59
DOX2100	60	HX0108	108	OX6202B-CFG	59
DOX3104	63	HX0112	51	OX6202B-CSD	59
DOX3304	63	HX0130	74	OX6202B-CSDO	59
E					
Soft case AE0190	106	HX0190	72	OXi6204	59
G					
GX1025	88	HX0191	72	OX7202-BUS	72
GX1050	88	HX0206	109	OX7042-CSD	69
GX305	86	HX0210	109	OX7042-MSD	69
GX310	86	HX0220	109	OX7042P-CSDK	69
GX310-P	86	HX2002	33	OX7062-CSD	69
GX320	86	L			
GX320-E	86	LX1600-PC	54	OX71	56
H					
HA030-1	93	M			
HA050	93	MC0159B	106	OX7102-CSD	69
HA050-1	93	MC0160B	106	OX7104-CSD	69
HA2004-Z	114	MTX1032-B	110	OX7104-CSDO	69
HA2005	114	MTX1032-BRK	110	OX7104P-CSDK	69
HX0003	108	MTX1032-C	110	OX7202-CSD	69
HX0004	108	MTX1032-CRK	110	OX7204-BUS	72
HX0005	108	MTX1050-PC	79	OX7204-CSD	69
HX0006	108	MTX1052B-PC	55	OX7204-CSDO	69
HX0007	108	MTX1052B-RK	55	P	
HX0008	108	MTX1052BW-PC	55	PO1101846	99
HX0009	108	MTX1052CW-PC	55	PO1101846	110
HX0010	106	MTX1054B-PC	55	PO1101847	99
HX0011	39	MTX1054B-RK	55	PO1101847	110
HX0012	39	MTX1054B-RK	55	PO1101892A	93
HX0013	39	MTX1054BW-PC	55	PO1101892A	110
HX0018	102	MTX1054CW-PC	55	PO1101914	110
HX0021	39	MTX112U	53	PO1101965	96
HX0024	111	MTX162UE	52	PO1101966	96
HX0027	109	MTX162UEW	52	PO1101967	96
HX0028	75	MTX202-Z	17	PO1101968	95
HX0029	75	MTX203-Z	17	PO1102019	44
HX0030B	74	MTX2022W-P	55	PO1102021	44
HX0031	74	MTX2024W-P	55	PO1102034	9
HX0032	74	MTX3290	25	PO1102053Z	98
HX0033	74	MTX3291	25	PO1102055Z	99
HX0034	73	MTX3292	27	PO1102082	63
HX0035B	74	MTX3292-BT	27	PO1102084	9
HX0036	74	MTX3293	27	PO1102084A	44
HX0038	111	MTX3293-BT	27	PO1102086	95
HX0050	33	MX0001-T	13	PO1102087	109
HX0051B	23	MX0002B	13	PO1102101Z	99
HX0052	23	MX0002BT	13	PO1102101Z	110
HX0052B	20	MX0024B-CL	26	PO1102106Z	99
HX0052C	23	MX0024B-CZ	26	PO1102107Z	99
HX0053	20	MX0024-CG	26	PO1105101Z	11
HX0055	33	MX0024-CL	26	PO1105101Z	94
HX0056-Z	20	MX0057CX	21	PO1105102Z	94
HX0057	111	MX0350-Z	36	PO1105105Z	94
HX0059	33	MX0355-Z	36	PO1120040A	96
HX0064	99	MX0407	43	PO1120043A	108
HX0071	74	MX0435D	44	PO1120047*	108
HX0072	73	MX0604	42	PO1120057A	108
I					
J					
K					
L					
M					
N					
O					
P					
Q					
R					
S					
T					
U					
V					
W					
X					
Y					
Z					

Reference	Page	Reference	Page	Reference	Page
P01120305	94	P01295450Z	102	P03652909	104
P01120308	108	P01295451Z	102	P03652910	104
P01120309	97	P01295452Z	102	P03652913	104
P01120401	94	P01295453Z	102	P03652914	104
P01120402	11	P01295454Z	102	P03652917	104
P01120402	94	P01295455Z	102	P03652918	104
P01120405	94	P01295456Z	102	P03652919	104
P01120409	108	P01295457Z	102	P03652920	104
P01120415	94	P01295458Z	102	P03652921	104
P01120416	94	P01295459Z	99	P03652922	104
P01120421	44	P01295460Z	98	P06239307	99
P01120421	97	P01298004	107	PA4119-50	110
P01120501	95	P01298068	107	PX0110	39
P01120502	95	P01298069	107	PX0120	39
P01120503	95	P01298071	107		
P01120504	95	P01298072	107	S	
P01120505	95	P01330401	39	SX-ACQ.V2	28
P01120506	95	P01637301	34	SX-ASYC2C/B	33
P01120507	95	P01651610Z	67	SX-ASYC2HD	33
P01120508	95	P01652401Z	67	SX-DMM2	33
P01120509	95	P01652411Z	67	SX-DMMBT/B	33
P01120560	95	P03197521A	93	SX-DMMK2	33
P01120561	95	P03197522A	93	SX-PROG.1	33
P01120562	95	P03197523A	93		
P01120563	95	P03197524A	93	T	
P01120564	95	P03197525A	93	TX0001-Z	10, 11
P01120565	95	P03197526A	93	TX001-Z	10
P01120570	109	P03197527A	93		
P01120571	109	P03197528A	93	V	
P01120572	109	P03295509	39	VX0003	11
P01196770	32	P03652712	105	VX0100	11
P01196770	33	P03652713	105		
P01197401	93	P03652714	105		
P01197402	93	P03652715	105		
P01197403	93	P03652901	104		
P01197404	93	P03652902	104		
P01295073A	89	P03652903	104		
P01295073A	110	P03652904	104		
P01295288Z	98	P03652905	104		
P01295289Z	98	P03652906	104		
P01295290Z	98	P03652907	104		
P01295293	33	P03652908	104		



ENERDIS

16, rue Georges Besse - Silic 44
92182 ANTONY Cedex - FRANCE
Tel.: +33 1 75 60 10 30
Fax: +33 1 46 66 62 54
info@enerdis.fr - www.enerdis.fr



PYROCONTROLE

6 bis, av du Docteur Schweitzer
69881 MEYZIEU Cedex - FRANCE
Tel.: +33 4 72 14 15 40
Fax: +33 4 72 14 15 41
info@pyrocontrole.com
www.pyrocontrole.com



MANUMESURE

248, av des Grésillons
92600 ASNIÈRES sur SEINE - FRANCE
Tel.: +33 1 75 61 01 90
Fax: +33 1 47 33 28 02
info@manumasure.fr
www.manumasure.fr

A STRUCTURE BASED ON LOCAL AGENCIES IN FRANCE

LILLE

Tel.: 03 20 55 96 41 - Fax: 03 20 06 33 61
agence.lille@chauvin-arnoux.fr

LYON

Tel.: 04 72 65 77 60 - Fax: 04 78 03 15 39
agence.lyon@chauvin-arnoux.fr

NANCY

Tel.: 03 83 92 19 21 - Fax: 03 83 90 32 11
agence.nancy@chauvin-arnoux.fr

NANTES

Tel.: 02 40 84 01 16 - Fax: 02 40 75 35 55
agence.nantes@chauvin-arnoux.fr

PARIS

Tel.: 01 44 85 45 75 - Fax: 01 46 27 07 48
agence.paris@chauvin-arnoux.fr

TOULOUSE

Tel.: 05 62 74 50 30 - Fax: 05 61 71 45 06
agence.toulouse@chauvin-arnoux.fr

INTERNATIONAL

190, rue Championnet - 75876 PARIS Cedex 18 - FRANCE
Tel.: +33 1 44 85 44 38 - Fax: +33 1 46 27 95 59
export@chauvin-arnoux.fr - www.chauvin-arnoux.fr

10 subsidiaries spread across the world

GERMANY

CHAUVIN ARNOUX GMBH

Ohmstraße 1
77694 KEHL / RHEIN
Tel.: +49 7851 99 26-0 - Fax: +49 7851 99 26-60
info@chauvin-arnoux.de
www.chauvin-arnoux.de

AUSTRIA

CHAUVIN ARNOUX GES.M.B.H

Slamastrasse 29/2/4
1230 WIEN
Tel.: +43 1 61 61 9 61 - Fax: +43 1 61 61 9 61-61
vie-office@chauvin-arnoux.at
www.chauvin-arnoux.at

CHINA

SHANGHAI PU-JIANG ENERDIS

INSTRUMENTS CO. LTD
N° 381 Xiang De Road
3 Floor, Building 1
200081 SHANGHAI
Tel.: +86 21 65 21 51 96 - Fax: +86 21 65 21 61 07
info@chauvin-arnoux.com.cn

SPAIN

CHAUVIN ARNOUX IBÉRICA SA

C/ Roger de Flor N°293
1a Planta
08025 BARCELONA
Tel.: +34 902 20 22 26 - Fax: +34 934 59 14 43
info@chauvin-arnoux.es
www.chauvin-arnoux.es

ITALY

AMRA SPA

Via Sant'Ambrogio, 23
20846 MACHERIO (MB)
Tel.: +39 039 245 75 45 - Fax: +39 039 481 561
info@amra-chauvin-arnoux.it
www.chauvin-arnoux.it

MIDDLE EAST

CHAUVIN ARNOUX MIDDLE EAST

PO Box 60-154
1241 2020 JAL EL DIB
(Beyrouth) - LIBAN
Tel.: +961 1 890 425 - Fax: +961 1 890 424
camie@chauvin-arnoux.com
www.chauvin-arnoux.com

UNITED KINGDOM

CHAUVIN ARNOUX LTD

Unit 1 Nelson Ct, Flagship Sq
Shaw Cross Business Pk, Dewsbury
West Yorkshire - WF12 7TH
Tel.: +44 1924 460 494 - Fax: +44 1924 455 328
info@chauvin-arnoux.co.uk
www.chauvin-arnoux.com

SCANDINAVIA

CA MÅTSYS TEM AB

Sjöflygvägen 35
SE-183 62 TABY
Tel.: +46 8 50 52 68 00 - Fax: +46 8 50 52 68 10
info@camatsystem.com
www.camatsystem.com

SWITZERLAND

CHAUVIN ARNOUX AG

Moosacherstrasse 15
8804 AU / ZH
Tel.: +41 44 727 75 55 - Fax: +41 44 727 75 56
info@chauvin-arnoux.ch
www.chauvin-arnoux.ch

USA

CHAUVIN ARNOUX INC

d.b.a AEMC Instruments
200 Foxborough Blvd.
Foxborough - MA 02035
Tel.: +1 (508) 698-2115 - Fax: +1 (508) 698-2118
sales@aemc.com
www.aemc.com

Metrix is a brand of Chauvin Arnoux



190, rue Championnet - 75876 PARIS Cedex 18 - FRANCE
info@metrix.fr - www.metrix.fr